

# Courtyard Walls by Allan Block<sup>®</sup>

*Complete Guide for using AB Courtyard.  
See How Easy it is to build Outdoor Kitchens,  
Fire Pits, Patio Walls and More. Check Out  
all of the Patio Ideas with AB Courtyard.*

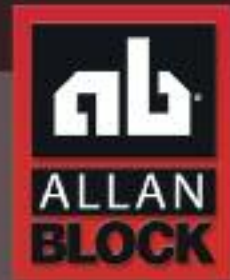

[allanblock.com](http://allanblock.com)



Download the  
AB Courtyard  
Estimating App  
Today!



## AB Courtyard Collection®

The AB Courtyard Collection is a durable, versatile and a cost-effective way to bring value into your landscaping. This two-sided free standing wall system's unique design can be used in many different applications. Check out the projects shown here or visit our website for more ways to enhance your outdoor living space.



[allanblock.com](http://allanblock.com)



For over twenty five years Allan Block has been bringing innovative products to the landscape community. We can provide quality and performance to any project with our line of products. You can be confident you are making the right choice with any Allan Block product.

Visit our website at [allanblock.com](http://allanblock.com) to find information about *Going Green with Allan Block* or to locate your closest AB Dealer/Distributor for pricing, availability, color selections and much more.

Visit [allanblock.com](http://allanblock.com).

## Table of Contents

2-11	Inspiring Ideas
12-15	The Courtyard Blocks
12	Estimating Charts

### Basic Building Principles

16	Build an AB Courtyard Wall Panel
18	Build an AB Courtyard Post/Pillar
20	Build Walls and Posts/Pillars Together
22	Build Curved Walls/Large Radii
24	Building with Corners
26	Ending Wall Panels
21, 25, 27	Modifying / Cutting Blocks
28	Retaining Soil

### Weekend Projects

30	Patio Enclosure
30	Light Post
31	Fire Pits
32	Outdoor Kitchen & BBQ Grilling Station
33	Ponds
34	Entry Monuments
35	Garden Bench
35	Backyard Couch
36-37	Basic Tips for Building With Courtyard

For a complete library of [installation videos](#), [detailed instructions](#), [estimating tools](#), [photo gallery](#), and [much more](#) visit our website at [allanblock.com](http://allanblock.com).



Download the AB Courtyard Estimating App Today.

Visit [allanblock.com](http://allanblock.com).



Patio Enclosures



Privacy Fencing



Fire Pits/Ponds



Lighting

Outdoor Kitchens





***Create New Outdoor Rooms With Beautiful Patio Enclosures.***



# Patio Walls



[allanblock.com](http://allanblock.com)

*Whether you use your patio to entertain once or twice a year or every weekend, seating walls can provide you with additional seating necessary for any occasion. Designed to fit any existing patio configurations, these stone-like enclosures can be anything from strictly aesthetic to beautifully functional.*



Visit [allanblock.com](http://allanblock.com).



# Outdoor Kitchens



[allanblock.com](http://allanblock.com)

*Outdoor kitchens are a natural extension of your home that allow you to do everything from hosting extravagant dinner parties to intimate alfresco dining for more casual everyday enjoyment. When the weather gets warm and the dining and entertaining moves outside enjoy the benefits of your own outdoor kitchen.*



***Cook, Dine and Entertain Guests in your Outdoor Kitchen.***



Visit [allanblock.com](http://allanblock.com).



***Build Lasting Relationships with Relaxing Places to Gather.***





# Enjoy Fire and Water



[allanblock.com](http://allanblock.com)

*Accessorize your backyard with beautiful amenities like a fire pit or pond. Extend your backyard use into fall and winter with the crackle and glowing warmth of a built-in fire pit. Find peace and relaxation with the sights and sounds a tranquil pond. Whether you choose fire or water – or both; you can't go wrong.*



Visit [allanblock.com](http://allanblock.com).



# Accent Lighting



[allanblock.com](http://allanblock.com)

*With all the hard work you have done to make your backyard dreams a reality, don't let them disappear when darkness falls. Accent lighting is a great way to highlight the best features of your outdoor space and allows you to enjoy the space after dark. So shine some light on your landscape all night long.*



***Enjoy Your Outdoor Entertaining Areas Long Into the Evening.***



Visit [allanblock.com](http://allanblock.com).



***Borders and Privacy Screening Add Definition and Style.***



# Fences



[allanblock.com](http://allanblock.com)

*Every masterpiece needs a frame. Adding a decorative fence will not only frame your yard with privacy and security, but adds style and beauty to your outdoors. Define your space into usable outdoor rooms; add charm to a garden or vertical textures to your patio and enhance your backyard masterpiece.*



Visit [allanblock.com](http://allanblock.com).



Download App Today!

Design & estimate your perfect courtyard patio with this useful tool from Allan Block. Take your simple backyard and transform your space by adding walls with corners, posts, curves and more the possibilities are endless.

Receive a full estimate report with detailed drawings for Free using the AB Courtyard App. Download your copy today.



Number of AB Dublin Blocks Needed					
Approximate Wall Height	Wall Length				
	4 ft 1.2 m	5 ft 1.5 m	8 ft 2.4 m	12 ft 3.7 m	20 ft 6.1 m
1 course 6 in. (150 mm)	3	4	6	9	15
2 courses 12 in. (300 mm)	6	8	12	18	30
3 courses 18 in. (450 mm)	9	12	18	27	45
4 courses 24 in. (600 mm)	12	16	24	36	60
5 courses 30 in. (750 mm)	15	20	30	45	75
Wall Caps Needed	6	8	12	18	30

For wall panels using AB York blocks, just double the numbers above.

The AB Courtyard Collection can be used for small retaining wall applications. See page 28 for more information.

For estimating more detailed projects with a combination of block sizes, curved or straight walls, see the estimating tools at allanblock.com or contact your local AB Distributor.

Number of Corner Blocks Needed for Posts/Pillars					
Approximate Post/Pillar Height	Number of Posts/Pillars				
	1	2	3	4	5
2 courses 12 in. (300 mm)	8	16	24	32	40
3 courses 18 in. (450 mm)	12	24	36	48	60
4 courses 24 in. (600 mm)	16	32	48	64	80
5 courses 30 in. (750 mm)	20	40	60	80	100
6 courses 36 in. (900 mm)	24	48	72	96	120
Post Caps Needed	2	4	6	8	10

Wall Caps

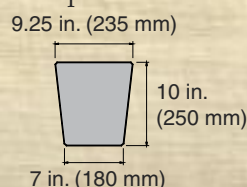

Height: 3.5 in (90 mm)  
Weight: 22 lbs (10 kg)

Post Caps

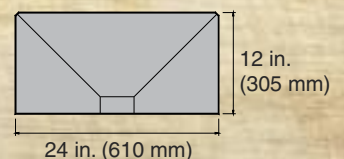

Height: 3.0 in (75 mm)  
Weight: 70 lbs (32 kg)

All measurements shown here are for reference only.

Visit [allanblock.com](http://allanblock.com).

# The Courtyard Blocks



allanblock.com

The AB Courtyard Collection is a two-sided free standing patio wall system that has three main components plus caps - AB Dublin, AB York and a Corner Block. Modification of the blocks may be necessary to build a project. See page 36-37 to show a complete reference guide for using the AB Courtyard Collection.

## AB Dublin Block

The AB Dublin Block is an angled block available in left and right angles. There are two raised rings on the top of the block, these interlock the blocks together so adhesive is not needed.

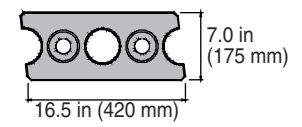
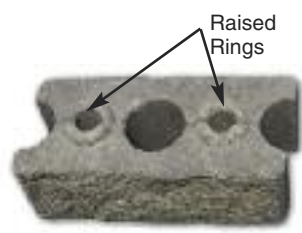

Height: 6.0 in (150 mm)  
Weight: 39 lbs (18 kg)

### Cutting Locations for the AB Dublin

**1/2 length** - 8.25 in. (210 mm)

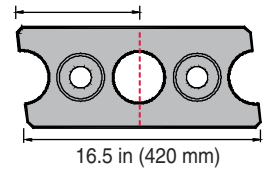

**1/2 length** - 8.25 in. (210 mm)

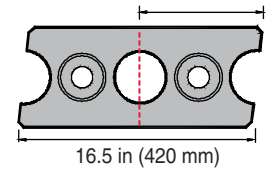

**3/4 length** - 12.25 in. (310 mm)

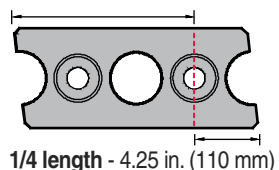

Modify the blocks down the center of the holes.

*Note: The AB Dublin can be installed upside down when the opposite angle is needed during construction. This should typically only be done on the top course.*

## AB York Block

The AB York Block is a tapered block, with a long and a short side. Modifying this block is done only when AB Dublin Blocks are not available.

### Cutting Locations for the AB York

**1/2 length** - 4.5 in. (115 mm)

Modify the block down the center of the hole.

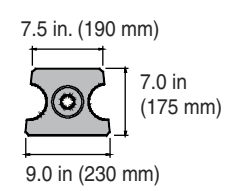

Height: 6.0 in (150 mm)  
Weight: 20 lbs (9 kg)

## Corner Block

The Corner Block is an angled block. The block has no designated top or bottom; flipping it over creates the opposite angle.

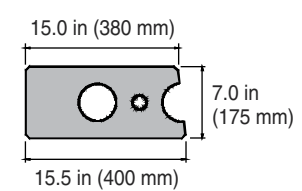

Height: 6.0 in (150 mm)  
Weight: 42 lbs (19 kg)

*All measurements shown here are for reference only.*

Visit [allanblock.com](http://allanblock.com).

# Features and Options

*The AB Courtyard Collection is versatile and provides unlimited possibilities. No different than the colorful interlocking toy blocks of your past. Create outdoor spaces that are comfortable yet elegant for entertaining. Incorporate custom gates, counter tops, natural stone or pavers as beautiful accents for even more style. Illuminate the evening easily by adding lighting to the landscape. Choose between the two textures as well as create a pattern with the different block shapes in your project for a custom look that endures the test of time.*

## Textures

The AB Courtyard Collection is available in two different textures, the Classic Cut Stone look of Courtyard and the Tumbled Old World look of Old Country Courtyard. Check with your local AB Dealer/Distributor for color selection and availability.



Courtyard



Old Country Courtyard

## Patterns

Using the AB York and the AB Dublin together in random patterns creates added dimension and style to any project.

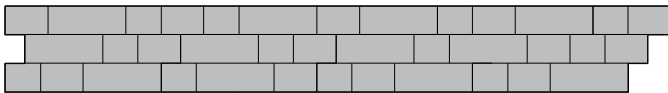

Patterned Walls



# Retaining Walls, Courtyard and Pavers



[allanblock.com](http://allanblock.com)

*The Allan Block line of retaining wall products and the AB Courtyard Collection work perfectly together in matching colors and textures to create beautiful raised patios. Find your favorite paver style to finish off and to create an outdoor area with elegant style.*



Visit [allanblock.com](http://allanblock.com).

# Building an AB Courtyard Wall Panel



## INSTALLING ON EXISTING PATIOS OR PAVEMENT

### Step 1: Layout

Determine the location of the wall panel on the existing surface. To ensure that the placement of the wall is straight, and in the desired location, use a string line. Go to Step 5.

## INSTALLING ON SOIL

### Step 1: Layout

Determine the location of the wall panel and lay the first course of block to determine the shape of the wall and to establish where to dig the trench. AB Dublin, AB York or both blocks together can be used for the base course. *See page 22 when building with curves and page 24 if corners will be needed. The AB Courtyard Collection can be used to retain up to two courses of soil, see page 28 for more information.*

### Step 2: Build Foundation\*

Mark the location of the wall with a shovel, remove the blocks and dig a level trench 3 in. deep and 7 in. wide (75 mm x 180 mm).

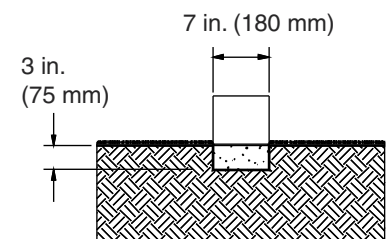

### Step 3: Fill

Place 3 in. (75 mm) of base rock in the trench and compact using a hand tamper. *See page 19 for information on proper base rock materials.*

### \*NOTE:

*The soil beneath the foundation pad must be a good quality compactable material. If soft soils are encountered, they will need to be removed and replaced with additional base rock. A good foundation will ensure a stable wall for years to come.*

### Step 4: Level

Level the base rock. We recommend using a 2x4 and a level to ensure the entire base is level. Make any adjustments as needed by adding or removing the base rock.



### Step 5: Build

Install the first two courses of block at the same time, tamping and leveling into place. Place 3-5 blocks in the trench, level, then place 3-5 blocks on the second course. Installing the first two courses at the same time will ensure that the blocks line up properly. The raised rings on the top of the blocks lock the courses together by fitting into the blocks above.



allanblock.com



### Step 6: Continue Building

Continue stacking courses of blocks in the pattern you have chosen until the desired height is achieved. Remember to offset the block seams on each course of blocks from the course below. *See the Helpful Tips below for additional information.*

### Step 7: Finish

Finish the wall with Wall Caps. On straight sections alternate the direction of the Wall Cap. On curved walls, place the short side of the caps on the inside of the curve. Secure the Wall Caps in place with a bead of flexible concrete adhesive along both sides of the raised rings and along the side of each Wall Cap.



### Helpful Tip:

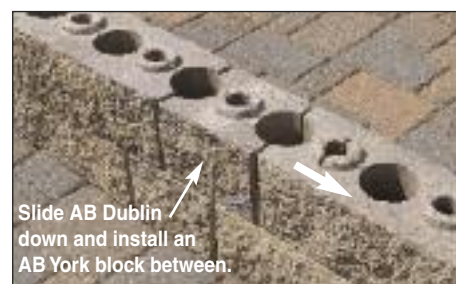
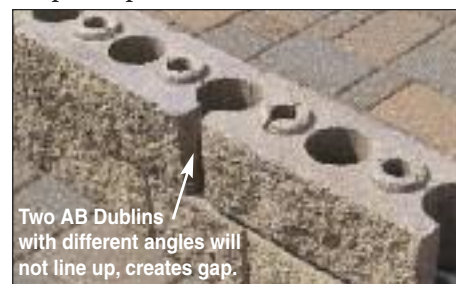

### HELPFUL TIPS:

**AB Dublin** - Install the same angled block one after another, to switch to the other angled AB Dublin, place an AB York block in between. (see photos at right).

**AB York** - For a straight panel, rotate every other block to create a straight section. For a curved panel, place the short side of the block facing the inside of the curve.

### Additional Information:

If taller walls are desired, additional construction information to ensure stability can be found on *How-to sheet #150 at allanblock.com.*

If building your wall panel with posts/pillars, interlock them together for added stability. *For more information see How-to sheet #230 at allanblock.com.*

Built on existing patio



Built on soil



Visit [allanblock.com](http://allanblock.com).

# Building an AB Courtyard Post/Pillar



## INSTALLING ON EXISTING PATIOS OR PAVEMENT

### Step 1: Layout

Determine the location and placement of the post/pillar on the existing surface. Go to Step 5.

## INSTALLING ON SOIL

### Step 1: Layout

Determine the location of the post/pillar and lay the first course of block to establish where to dig the foundation pad.

### Step 2: Build Foundation\*

Mark the location of the post/pillar with a shovel, remove the blocks and dig a hole 24 in. square and 4 in. deep (600 mm x 100 mm).

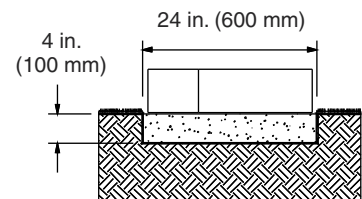

### Step 3: Fill

Place 4 in. (100 mm) of base rock in the hole and compact using a hand tamper. *See page 19 for information on proper base rock materials.*

### \*NOTE:

*The soil beneath the foundation pad must be a good quality compactable material. If soft soils are encountered, they will need to be removed and replaced with additional base rock. A good foundation will ensure a stable post/pillar for years to come.*

### Step 4: Level

Level the foundation pad. Make any adjustments as needed by adding or removing the base rock.



### Step 5: Build

Install the first course with 4 Corner Blocks with the long sides facing out. Square up the blocks, tamp into place and level.

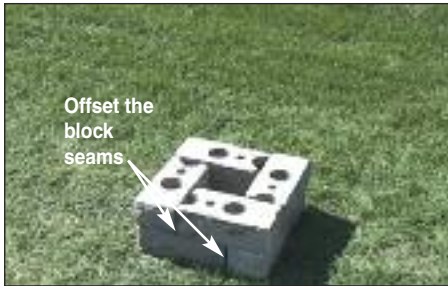

### Step 6: Continue Building

Continue stacking courses, alternating between the patterns shown to offset the seams from the course below until the desired height is achieved. Do not stack the blocks up using only one pattern (seams should not create a straight line the full height of the post/pillar).



allanblock.com

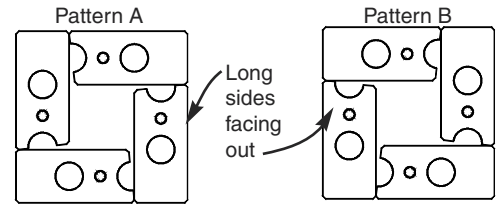

### Step 7: Finish

Finish the post/pillar with two Post Caps. Secure the Post Caps in place with a bead of flexible concrete adhesive along the outside edge of the top course of Corner Blocks and then set the Post Caps in place.

### Additional Information:

If taller posts/pillars are desired, *additional construction information to ensure stability is available on How-to sheet #140 at allanblock.com.*

Built on existing foundation



Built on soil



## Base Rock Materials when Building on Soil

Using the proper materials to create the base foundation for wall panels and post/pillars is important when building on soil. We recommend using a compactible base rock material that is gravel in varying sizes of angular or smooth aggregates similar to the wall rock used in retaining walls or a road/paver base type material.



Wall Rock



Road/Paver Base

Visit [allanblock.com](http://allanblock.com).

# Building AB Courtyard Walls and Posts/Pillars Together

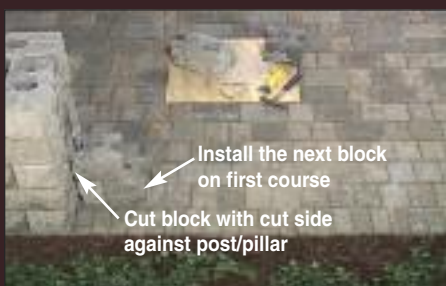

## Step 1: Layout

Determine the location of the first post/pillar. Install the post/pillar using Corner Blocks with the long sides facing out. Align and level each course to desired height. Alternate the blocks per course to offset the seams from the blocks below. Make adjustments as needed. *For proper construction on soil, see page 16 for wall panels and page 18 for posts/pillars.*

## Step 2: Begin Panel

The first and the last block of every course of wall panel between the posts/pillars will be a cut block. Using a cut block allows the panel to be flush with the post/pillar. If a standard angled block shape is used there will be a gap where the panel meets up with the post/pillar. Cut an AB Dublin to achieve a quarter (1/4) and three-quarter (3/4) length piece to start the first course. Place the quarter (1/4) piece with the cut side against the center of the post/pillar to start the first course followed by the next full block. Use the three-quarter (3/4) length piece to complete the end of this course where it will meet up with the next post/pillar. We recommend installing the first two courses of the wall panel at the same time to ensure proper alignment.

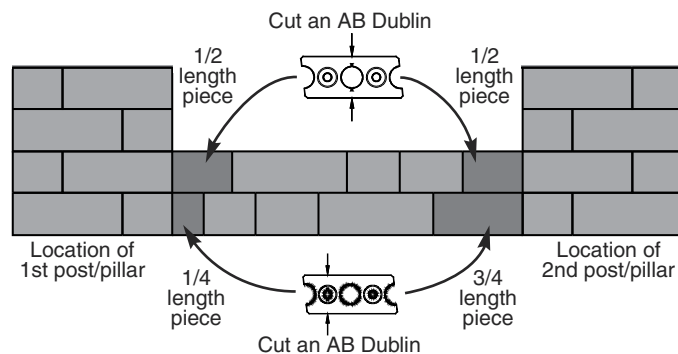

## Step 3: Second Course

On the next course, cut an AB Dublin in half (1/2) to start this course. Place one half of this block with the cut side against the post/pillar. Again, save the other half of this piece for the end of this course. To aid in fitting the cut blocks, try flipping them over so the raised rings are down.

## Step 4: Build Panel

With the first two courses started, continue building the wall panel in the chosen pattern. Build to the location of the next post/pillar. At the end of each section place the remaining cut blocks (the 3/4 and 1/2 length pieces) on each course that was used to start the course.

Visit [allanblock.com](http://allanblock.com).



### Step 5: Additional Posts/Pillars

At the end of the wall panel, install the next post/pillar as previously done. Place the Corner Blocks with the long sides facing out. Install additional courses until the desired height is achieved. Alternate the blocks to offset the seams from the blocks below.



allanblock.com

### Step 6: Continue Building

With both posts/pillars built, continue stacking the courses of the wall panel to the desired height. Alternate the type of cut blocks for each course as you go.



Finish wall panel to desired height.

### Step 7: Finish

Finish the wall with Wall and Post Caps. Secure the Wall Caps in place with a bead of flexible concrete adhesive along both sides of the raised rings and along the side of each Wall Cap. Before installing the Post Caps, place a bead of adhesive along the outside edge of the top course of Corner Blocks. Set the Post Caps in place.



Install Post and Wall Caps

### Additional Information:

If taller walls and posts/pillars are desired, *additional construction information to ensure stability is available on How-to sheet #140 & #150 at allanblock.com.*

Added stability for the wall can be achieved by interlocking the walls and posts/pillars together. *For more information see How-to sheet #230 at allanblock.com.*

## Modifying Blocks

The AB Courtyard Collection blocks come with a built in angle, by cutting the blocks at a quarter (1/4), half (1/2) or three-quarter (3/4) length, you create a straight side to the block. See page 13 for detailed information as to where the blocks are to be cut to fit properly. The straight side that is created with cutting is needed when meeting up with a flat surface or when building curves within a wall panel. You can modify the blocks using a hammer and chisel when splitting or a saw with a masonry blade when cutting the block. Some of the blocks are produced with pre-marked cutting/splitting notches for ease of locating the cut line, but any of the blocks can be modified.

### SAFETY FIRST

*Always wear safety glasses when modifying a block. A dust mask and ear protection is also recommended when cutting block.*

### Hammer and Chisel

Use a hammer and chisel, tap around the entire block in the same location where the split is needed to create a quarter (1/4), half (1/2) or three-quarter (3/4) length piece. Then strike the chisel with more force in the score line to break the block.

### Saw Option

Use a circular saw to score around the entire block in the same location where the cut is needed to create a quarter (1/4), half (1/2) or three-quarter (3/4) length pieces. Then with a hammer and chisel, tap around the score line until the block splits. A masonry saw or a metal chop saw can also be used to make a complete cut through the block, eliminating the use of the hammer and chisel.

### Corner Blocks

The Corner Blocks can be cut or split using the same process described above.

*For more information see How-to sheet #210 at allanblock.com.*



Visit [allanblock.com](http://allanblock.com).

# Building Curved Walls with AB Courtyard



## BUILD A CURVE

The AB Courtyard Collection is designed to let you easily build curved and serpentine walls. Simply install the AB York blocks with the long side of the block facing the outside of the curve. When building curved walls it is best to build the first two courses at the same time. This helps align the blocks so additional courses continue to stack properly. *If building on soil, see page 10 to ensure a proper foundation is installed.*

## BUILD A CIRCLE

It takes 28 AB York blocks to make a complete circle. Install the AB York blocks with the long side of the block facing the outside of the circle. A pre-designed diameter for the circle is 81 in. (2.0 m). *See How-to sheet #200 at [allanblock.com](http://allanblock.com) for additional options, larger flowing curves and radii.*

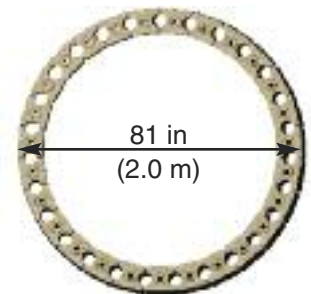

## BUILD A CURVE IN A WALL PANEL

### Step 1: Make Adjustments

Before beginning the curve check to make sure both courses are angled correctly. Both courses need to be parallel with each other and angled toward the direction of the curve. If one block is angled the opposite direction, remove the last block and slide the entire course over one block to correct.

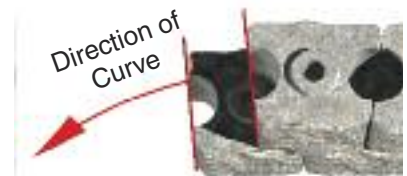

Courses must be parallel

### Step 2: Start of the Curve

On the first course, install an AB York block by placing the long side of the block facing the outside of the curve. On the second course, where the wall changes from a curve to a straight section, an AB Dublin will need to be cut in a half (1/2) length to be used at the transition. This transition piece will be needed on every other course. *See page 21 or How-to sheet #210 for information on modifying blocks.*





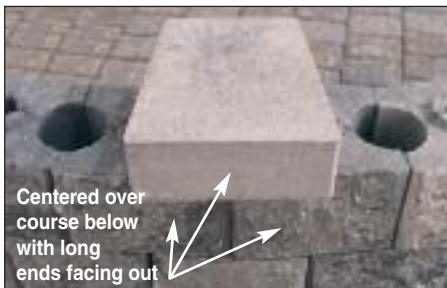
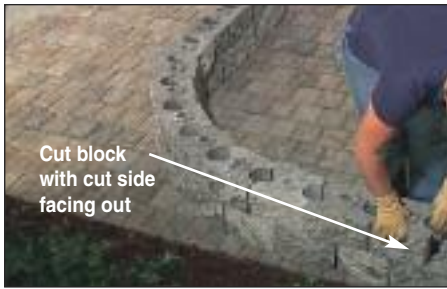

### Step 3: Build the Curve

With the curve started, stack additional courses using the AB York block and placing all of the blocks with their long sides facing the outside of the curve.

### Step 4: End of the Curve

To change the direction back to a straight wall, on the first course at the end of the curve, turn the AB York block around so the short side of the block is facing the outside of the curve. On the second course use the other AB Dublin half (1/2) length piece with the cut side facing out and toward the next section of the wall panel.

### Step 5: Additional Courses

Repeat this same process as described in Steps 2-4 for any additional courses. Every odd numbered course will be laid out exactly the same with block layout and where the cut blocks will be used. The same is true for all even numbered courses.

### Step 6: Finish

Finish the wall with Wall Caps. On curved walls, place the long end of the Wall Caps facing the outside of the curve. For proper alignment, start capping the wall at the curve and place the Wall Cap centered over two AB York blocks with their long ends facing out. To transition the Wall Caps back to a straight section, alternate the direction of the Wall Cap. Secure the Wall Caps in place with a bead of flexible concrete adhesive along both sides of the raised rings and along the side of each Wall Cap.



allanblock.com

## Larger Curves

### Building Larger Curves

If a larger curve (radius) is part of your patio wall project, cutting some AB Dublin blocks in half will be required, which allows just about any radius to be built. The easiest way to create a smooth curve is to alternate between an AB York block and a half (1/2) AB Dublin block through the entire curve. Limitless curves can be created by combining the various patterns shown here. AB Wall caps will need to be cut to follow any custom radius as well.

### Step 1: Cut AB Dublin Blocks in half

Cut 6 AB Dublins in half to start to assist with building the larger curve needed.

### Step 2: Layout Larger Curve

Layout your curve building 2 courses at the same time to ensure proper fit. Combine the patterns shown here to create a custom flowing curve.

### Step 3: Continue Building

Cut addition half AB Dublins as required and continue using the combination of patterns to achieve the curve required.

**NOTE:** By adding small gaps at a maximum 0.125 inch (3 mm), you can tighten the wall or feather it wider. When AB Dublin blocks are angled in the opposite direction, use those half AB Dublin blocks in Option C.

See page 37 or How-to sheet #200 for more information on larger curves and radii.

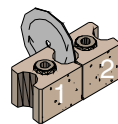

Cut AB Dublin blocks and place with AB York blocks to create custom curves.

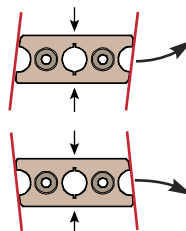

Use the properly angled AB Dublin block to build your curves. Option C works with both of these angles.

### Option A

2 AB York Block

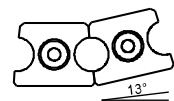

### Option B

1 AB York Block  
1 half AB Dublin

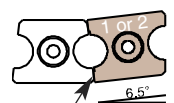

Half an AB Dublin, cut side.

### Option C

1 AB York Block  
1 Full AB Dublin-cut

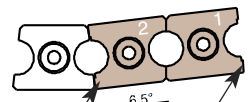

Cut sides of a cut AB Dublin. Note placement of cut sides.

### Option D

2 AB York Block  
1 half AB Dublin

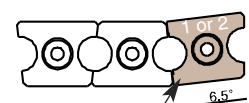

Half an AB Dublin, cut side.

Visit [allanblock.com](http://allanblock.com).

# Building Corners with AB Courtyard



## Build a Corner

The AB Courtyard Collection is designed to let you easily make corners using the Corner Block. Cutting blocks will be required on every course. *See page 21 or How-to sheet #210 for information on modifying blocks.*

### Step 1: Layout

Walls that have corners in the design will need to be built starting at the corner. Determine the location of the corner and place a Corner Block. Installing the first two courses at the same time will ensure proper alignment of the entire project.

### Step 2: Build the Corner

Cut an AB Dublin to achieve a quarter (1/4) and three-quarter (3/4) length piece. Place the cut end against the Corner Block to create the corner, see Pattern A. Cutting the block creates a straight edge so there will not be a gap where the blocks meet. An AB York cut to create a half (1/2) length block will also work.

Cut an AB Dublin to create a 1/4 and 3/4 length piece

#### Pattern A

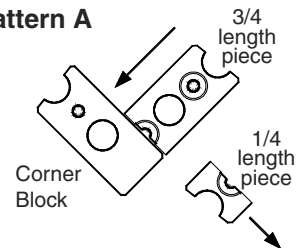

### Step 3: Second Course

On this course, alternate the position of the Corner Block to face the opposite direction of the one on the first course, see Pattern B. Use the remaining cut piece and place it with the cut side against the corner to finish the corner.

#### Pattern B

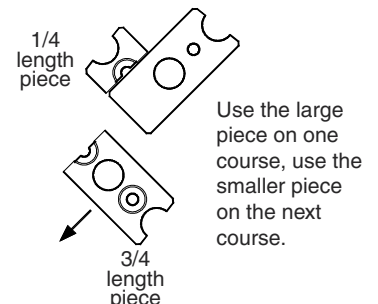

### Step 4: Continue Building

Build the remaining wall out in both directions in the pattern chosen. Use the above process for any additional courses or corners in the project. To aid in fitting the cut blocks, try flipping them over so the raised rings are down.

Visit [allanblock.com](http://allanblock.com).



### Capping a Corner

#### Step 1: Wall Caps First Direction

Finish the corner with Wall Caps. Starting at the corner, place the first two Wall Caps following the wall in the same direction. Place the first Wall Cap with the long end facing the outside of the wall. Alternate the direction of the second Wall Cap for a straight wall.



allanblock.com



#### Step 2: Wall Caps Second Direction

Next place a Wall Cap on the other side of the corner. Place the short end of the Wall Cap facing the outside of the wall. Make adjustments to the first two Wall Caps to ensure they line up properly at the corner.

#### Step 3: Finish

Secure the Wall Caps in place with a bead of flexible concrete adhesive along both sides of the raised rings and along the side of each Wall Cap.



### WALL CAP DETAIL - CHECK FOR AVAILABILITY

The majority of the Wall Caps are manufactured with a notch in the bottom that allows for placement on the wall panel with the raised rings from the blocks below.



Some Wall Caps may be manufactured with a solid edge for use when ending walls. Check with your distributor for availability.

## Modifying Wall Caps for Corners (Optional)

### CUTTING CAPS TO CREATE 90° CORNER

Finishing the corner with Wall Caps can simply be done as shown above by placing the blocks to create the corner. Modifying two caps slightly will give the corner a more refined look.

#### Step 1: Mark and Cut Caps

Using a tape measure and straight edge, mark the cut line on two cap blocks as shown. Use a masonry saw with a dry cutting diamond blade to make a complete cut.

#### Step 2: Place Caps on Corner

Place the cut caps on the corner as shown. Continue stacking additional caps out from the corner.

#### Step 3: Finish

Secure the Wall Caps in place with a bead of flexible concrete adhesive along both sides of the raised rings and along the side of each Wall Cap.

### SAFETY FIRST

*Always wear safety glasses when splitting or cutting block. A dust mask and ear protection is also recommended when cutting block.*

#### Step 1

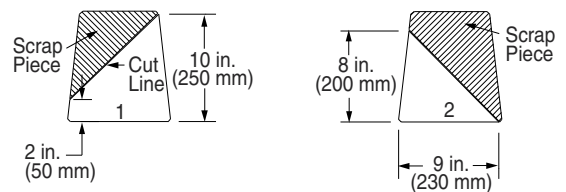

#### Step 2

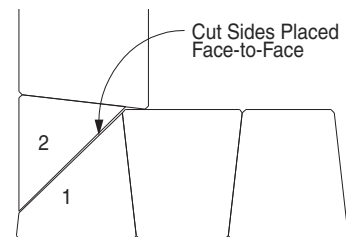

# Ending Wall Panels with AB Courtyard



The AB Courtyard Collection is designed to let you easily step down or end the walls in a number of ways. You can also end a wall panel at a post/pillar, *see page 20 for more information.*

## USE CORNER BLOCKS TO END THE WALL

### Option 1:

#### Step 1: Install Corner Block

Place Corner Blocks as the last block so that the blocks step back on each course to give the wall a finished look.

#### Step 2: Install Wall Cap

Secure the Wall Caps in place with a bead of flexible concrete adhesive along both sides of the raised rings and along the side of each Wall Cap.

## USE CORNER BLOCKS FOR A GRADUAL STEP DOWN

### Option 2:

This option may require cutting a Wall Cap to fill a gap on each course.

#### Step 1: Install Corner Block

Place blocks on each course to end the wall in the look you want. The larger the space between courses, the longer the staggered look will be.

#### Step 2: Install Wall Caps

Place Wall Caps on the panel with the cap tight against the Corner Block that is ending the course above.

#### Step 3: Adjust

If the gap at the end of the wall is not the look you desire, slide the entire course of caps to the end of the wall, measure the gap and cut a Wall Cap to fit. *See Option 3 or How-to sheet #210 for information on modifying blocks.*

#### Step 4: Finish

Secure the Wall Caps in place with a bead of flexible concrete adhesive along both sides of the raised rings and along the side of each Wall Cap.

Visit [allanblock.com](http://allanblock.com).



## USE EXTRA WALL CAPS FOR A STAGGERED LOOK

### Option 3:

This option requires cutting a Wall Cap to fill a gap on each course.



allanblock.com

#### Step 1: Install Blocks

Place blocks on each course to end the wall in the look you want. The larger the space between courses, the longer the staggered look will be.



Measure and mark for the Wall Cap

#### Step 2: Install Wall Caps

Place Wall Caps on the panel with the Wall Cap even with the course below. This will leave a gap where a Wall Cap will need to be measured and cut to fit. *See below or How-to sheet #210 for information on modifying blocks.*

#### Step 3: Install Additional Wall Cap

Once the cut blocks are installed, place another Wall Cap where the course steps down to give the end a finished look.



Line up Wall Caps and end of course

Fill in gap with a cut Wall Cap

#### Step 4: Finish

Secure the Wall Caps in place with a bead of flexible concrete adhesive along both sides of the raised rings and along the side of each Wall Cap.



Modified Wall Cap

## Modifying Wall Caps for Wall Panels

### Step 1: Score Top of Block

Score the top and bottom of the block with a circular saw with a masonry blade.

### Step 2: Score Bottom of Block

Using a hammer and chisel, score the bottom of the block in notched area.

### Step 3: Split Block

Score the top with a chisel on the outer edges only. Strike harder blows in the scored area to split the block. **Do not score over the notch as the block will split the wrong way.**

### SAFETY FIRST

*Always wear safety glasses when splitting or cutting block. Dust masks and ear protection are also recommended when cutting block.*

Step 1



Step 2



Step 3

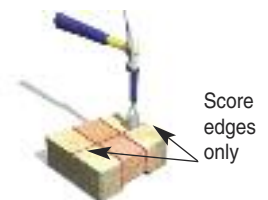

Visit [allanblock.com](http://allanblock.com).

# Retaining Soil using AB Courtyard



## Step 1: Layout

Determine the location of the wall panel and lay the first course of block to determine the shape of the wall and to establish where to dig the trench. AB Dublin, AB York or both blocks together can be used for the base course. *See page 22 when building with curves and page 24 if corners will be needed.*

## Step 2: Build Foundation\*

Mark the location of the wall with a shovel, remove the blocks, sod and other surface materials. Dig a level trench 8 in. deep and 12 in. wide (200 mm x 300 mm). On sloped sites, "step up" the base when it gets more than 6 in. (150 mm) deep, *see page 29 for more information.*

## Step 3: Fill

Place 6 in. (150 mm) of base rock in the trench and compact using a hand tamper. *See page 19 for information on proper base rock materials.*

### \*NOTE:

*The soil beneath the foundation pad must be a good quality compactable material. If soft soils are encountered, they will need to be removed and replaced with additional base rock. A good foundation will ensure a stable wall for years to come.*

## Step 4: Level

Level the base rock. We recommend using a 2x4 and a level to ensure the entire base is level. Make any adjustments as needed by adding or removing base rock.

## Step 5: Build

Place 3-5 blocks in the trench, with the raised rings facing up, leveling each block as you go. The raised rings on the top of the blocks lock the courses together. Using base rock, fill the block openings. Sweep the top of the blocks and install 3-5 blocks of the 2nd course. Installing the first two courses at the same time will ensure that the blocks line up properly.

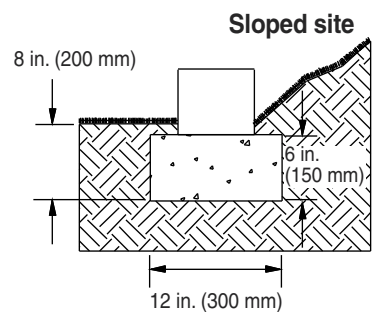
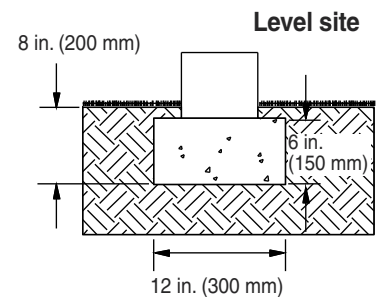



Install base rock in top of block openings



Offset the block seams



Compact soils with a hand tamper behind block



### Step 6: Build Next Section

Install the next section of the base course, leveling each block as you go. Fill all the block openings for the first and second course with base rock, then sweep the top of the blocks clean. Install the next section of the second course of blocks, offsetting the block seams from the course below then install base rock in the block openings. Use these steps, continue building the first and second course in sections for the length of the wall. *See the Helpful Tips on page 17 about block placement.*



allanblock.com

### Step 7: Wall Caps

Finish the wall with Wall Caps. On straight sections alternate the direction of the Wall Cap. On curved walls, place the short side of the caps on the inside of the curve. Secure the Wall Caps in place with a bead of flexible concrete adhesive along both sides of the raised rings and along the side of each Wall Cap. Completing the entire AB Courtyard wall prior to backfilling the retained soil is recommended.

### Step 8: Backfilling and Compaction

With the AB Courtyard wall finished and Wall Caps glued in place, backfill 6 in. (150 mm) of soil behind the block up to the top of the first course. Use a hand tamper to carefully compact soil thoroughly. Install another 6 in. (150 mm) of soil up to the top of the second course, again use a hand tamper to compact soil in place.

AB Courtyard can be built taller than two courses, but only a maximum height of two block courses can be used to retain soil. *For added stability options, see How-To Sheet #150 or to retain soil taller than shown here, see our Retaining Walls Installation guide for walls up to 6 ft. (1.8 m) tall using our retaining wall products at allanblock.com.*

Create a planting area

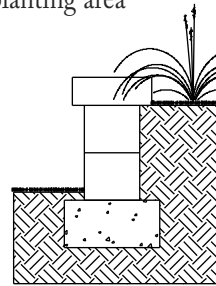

Create a patio wall

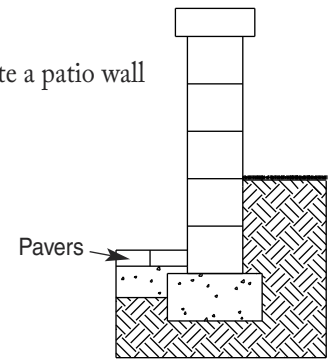

## Stepping Up the Base Course

### Building Step-Ups into the Slope

This can be easily done, by extending the base trench into the slope far enough to bury one block for each step up that is needed. Then continue with Step 3 and fill trench with base rock and compact to create a solid foundation.

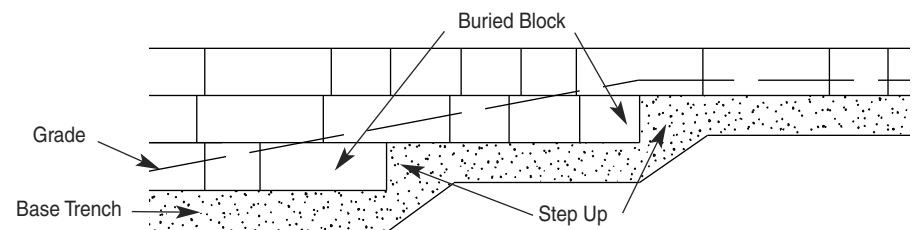

Visit [allanblock.com](http://allanblock.com).

# AB Weekend Projects

## Patio Enclosure

In no time you can be sitting on your patio and enjoying your new living space. For an added touch, install lighting features.



To build a Patio Enclosure you will need AB York, AB Dublin, AB Corners, and Post and Wall Caps. *See How-to Sheet #260 for complete details.*

- Step 1 - Measure existing patio and mark approximate location of posts/pillars, wall panels and openings to exit patio.
- Step 2 - Starting at the corner, install 2 courses at a time.
- Step 3 - Build out in both directions to the next post/pillar locations.
- Step 4 - Build posts/pillars and continue with any additional wall panels.
- Step 5 - Build additional courses.
- Step 6 - Install Wall and Post Caps.



## Light Post

Illuminate your entryway or landscape with a light post. The additional light will accent your surroundings and make a great impression with your guests.



To build a Light Post you will need AB Corners and Post Caps. *See How-to Sheet #170 for complete details.*

- Step 1 - Determine location and mark out with a shovel.
- Step 2 - Run electrical wiring per code.
- Step 3 - Prepare foundation pad and level.
- Step 4 - Build 1st course of post/pillar, level and adjust.
- Step 5 - Install additional courses to desired height.
- Step 6 - Modify and install Post Caps to allow for wiring.
- Step 7 - Install light fixture.





## Fire Pit - Square

Add a square fire pit to your paver or concrete patio quick and easy. Stack up the blocks using our predetermined patterns for even faster results. Add the fire ring and logs well before the weekend is over.



To build a Fire Pit you will need AB York, AB Dublin, AB Corners and Wall Caps. See *How-to Sheet #400* for complete details.

- Step 1 - Measure and mark approximate location.
- Step 2 - Build one corner, two courses high.
- Step 3 - Build out in both directions with AB York and AB Dublin blocks to the next three corners.
- Step 4 - Continue to height desired. Install Wall Caps.
- Step 5 - Install decorative rock.
- Step 6 - Place metal fire ring, wood and enjoy!



## Fire Pit - Circle

In just a few hours, you can be sitting in front of a roaring fire, with your feet up, enjoying the evening. Using the AB York and Wall Caps from the AB Courtyard Collection, you can add a beautiful accent to your landscape.

To build a Fire Pit you will need AB York blocks and Wall Caps. See *How-to Sheet #360* for complete details.

- Step 1 - Determine location and mark out with a shovel.
- Step 2 - Remove sod and dig trench for foundation.
- Step 3 - Prepare foundation pad and level.
- Step 4 - Install AB York blocks and Wall Caps.
- Step 5 - Install decorative rock.
- Step 6 - Place metal fire ring, wood and enjoy!



Visit [allanblock.com/projects](http://allanblock.com/projects) for complete installation details.

# AB Weekend Projects

## Outdoor Kitchen

By following the pre-set patterns, this kitchen goes up quickly. Adjustments can be made to accommodate larger grill sizes, or a longer counter top space to allow for shelving or a refrigerator.

To build an outdoor kitchen you will need AB York, AB Dublin, AB Corners, Wall Caps and a counter top material. See *How-to Sheet #341 for complete details.*

- Step 1 - Determine layout and location.
- Step 2 - Layout the first course, cutting blocks as needed.
- Step 3 - Layout the next 5 courses per the pattern, cutting blocks as needed.
- Step 4 - Install the top course following the pattern. This course needs to be installed with the raised rings down to allow placement of the Wall Caps and the counter top material.
- Step 5 - Install Wall Caps and chosen counter tops; secure with adhesive.
- Step 6 - Move the grill into place and you are ready to entertain in style.



## BBQ Grilling Station

By following the patterns for each course, your BBQ Grilling Station will be ready for use in no time. For a quick installation, build it on an existing patio area; information on building on alternative foundations is available at [allanblock.com](http://allanblock.com).

To build a BBQ Grilling Station you will need AB York, AB Dublin, AB Corners, Wall Caps and counter top material. See *How-to Sheet #290 for complete details.*

- Step 1 - Determine layout and location.
- Step 2 - Build first post/pillar following pattern.
- Step 3 - Build back wall panel.
- Step 4 - Build 2nd post/pillar.
- Step 5 - Build additional courses.
- Step 6 - Install Counter tops and Wall Caps.



## Below Ground Pond/Water Feature

To create a low profile accent to your yard or garden, add a below ground pond with the AB Courtyard Collection. You can be enjoying your new surroundings before the weekend is over.



To build a Below Ground Pond you will need AB York blocks and Wall Caps. See *How-to Sheet #310* for complete details.

- Step 1 - Determine location and mark out with a shovel.
- Step 2 - Remove sod and dig hole for foundation.
- Step 3 - Prepare foundation pad and level.
- Step 4 - Install temporary course of blocks for placement.
- Step 5 - Remove blocks and install flexible pond liner.
- Step 6 - Reinstall blocks.
- Step 7 - Backfill blocks and liner.
- Step 8 - Install top course of blocks and Wall Caps.
- Step 9 - Add decorative rock, fountain and water.



## Above Ground Pond/Water Feature

Easily enhance your flower garden with a beautiful water feature. With no special tools you can complete this quickly for a dramatic new look.

To build an Above Ground Pond you will need AB York blocks and Wall Caps. See *How-to Sheet #280* for complete details.

- Step 1 - Determine location and mark out with a shovel.
- Step 2 - Remove sod and dig trench for foundation.
- Step 3 - Prepare foundation pad and level.
- Step 4 - Install 3 courses of blocks.
- Step 5 - Install pond liner.
- Step 6 - Install Wall Caps.
- Step 7 - Install water feature and water.



Visit [allanblock.com/projects](http://allanblock.com/projects) for complete installation details.

# AB Weekend Projects

## Entry Monument with Planter

In just a weekend you can create a beautiful plantable entry monument that will give your yard great curb appeal.

To build an Entry Monument with a planter you will need AB York, AB Dublin, AB Corners, Post and Wall Caps. See *How-to Sheet #370 for complete details.*

- Step 1 - Determine location and mark out with a shovel.
- Step 2 - Remove sod or top soil and dig trench.
- Step 3 - Prepare foundation pad and level.
- Step 4 - Install 1st course of block following preset pattern.
- Step 5 - Install additional courses of back wall and posts/pillars.
- Step 6 - Install Wall and Post Caps.
- Step 7 - Fill planter with dirt and plant.



## Entry Monument

Add instant curb appeal to your entryway in just a weekend. For a dramatic look, add lighting or plantings to the top of the posts/pillars or decorate for the different seasons.

To build an eye catching Entry Monument you will need AB York, AB Corners, and Post and Wall Caps. See *How-to Sheet #300 for complete details.*

- Step 1 - Determine location and mark out with a shovel.
- Step 2 - Remove sod and dig trench for foundation.
- Step 3 - Prepare foundation pad and level.
- Step 4 - Install AB York blocks following pre-set pattern.
- Step 5 - Install Wall and Post Caps.



## Garden Bench

This project stacks up in no time. Just stack the AB Corner Block up in the pre-set patterns per course, place the Post Caps and a seating material and you are done.



To build an Outdoor Bench you will need AB Corners and Post Caps. See *How-to Sheet #320* for complete details.

- Step 1 - Determine location and mark out with a shovel.
- Step 2 - Remove sod and dig hole for each side.
- Step 3 - Prepare foundation pads and level.
- Step 4 - Build first post/pillar following pattern.
- Step 5 - Build second post/pillar following pattern.
- Step 6 - Install Post Caps and seating material.



## Backyard Couch

Do you entertain guests in your backyard or patio and wish you had more seating? This couch option is what you need. Stack up the blocks in the preset patterns; add caps and seating material and you are all set.



To build a Backyard Couch you will need AB York, AB Dublin, AB Corners and Wall Caps. See *How-to Sheet #350* for complete details.

- Step 1 - Determine layout and location.
- Step 2 - Install first 3 courses with preset pattern.
- Step 3 - Install next 3 courses with altered pattern.
- Step 4 - Install Wall Caps.
- Step 5 - Install seating and armrest material.



Visit [allanblock.com/projects](http://allanblock.com/projects) for complete installation details.

# Reference Guide for Building with AB Courtyard

## AB York Block



### Straight Walls

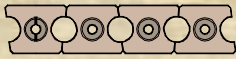

Alternate each block.

### Standard Curves

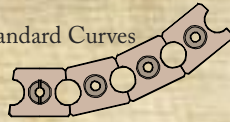

Keep all long sides together.

Modify block by cutting in 1/2.

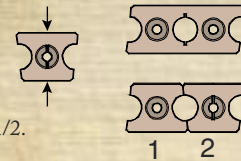

Two AB Yorks equal one AB Dublin block.

## AB Dublin Block



### Straight Walls

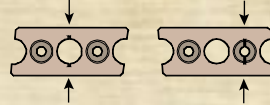

Modify blocks by cutting in 1/2 or 3/4 length.

## AB Corner Block



### Corners

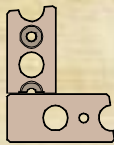

Modify AB Dublin block to make corner.

### Posts/Pillars

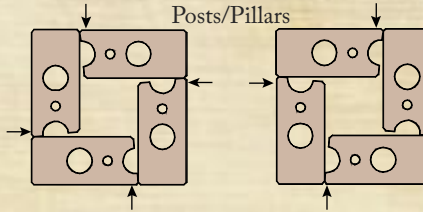

Place the blocks long side out to make posts/pillars.

## AB Wall Cap



### Straight Walls



### Standard Curves

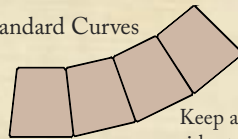

Keep all long sides together.

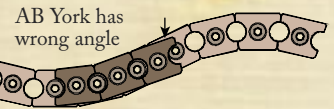

Use a cut AB Dublin on the even courses to transition from a radius to ensure proper alignment.

## AB Post Cap

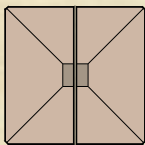

Two AB Post Caps per post/pillar

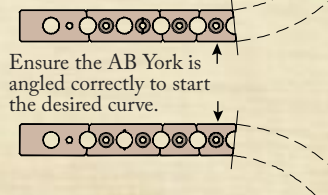

Ensure the AB York is angled correctly to start the desired curve.

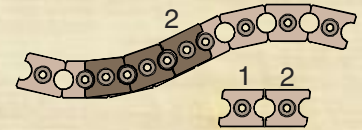

Cut AB Dublin block

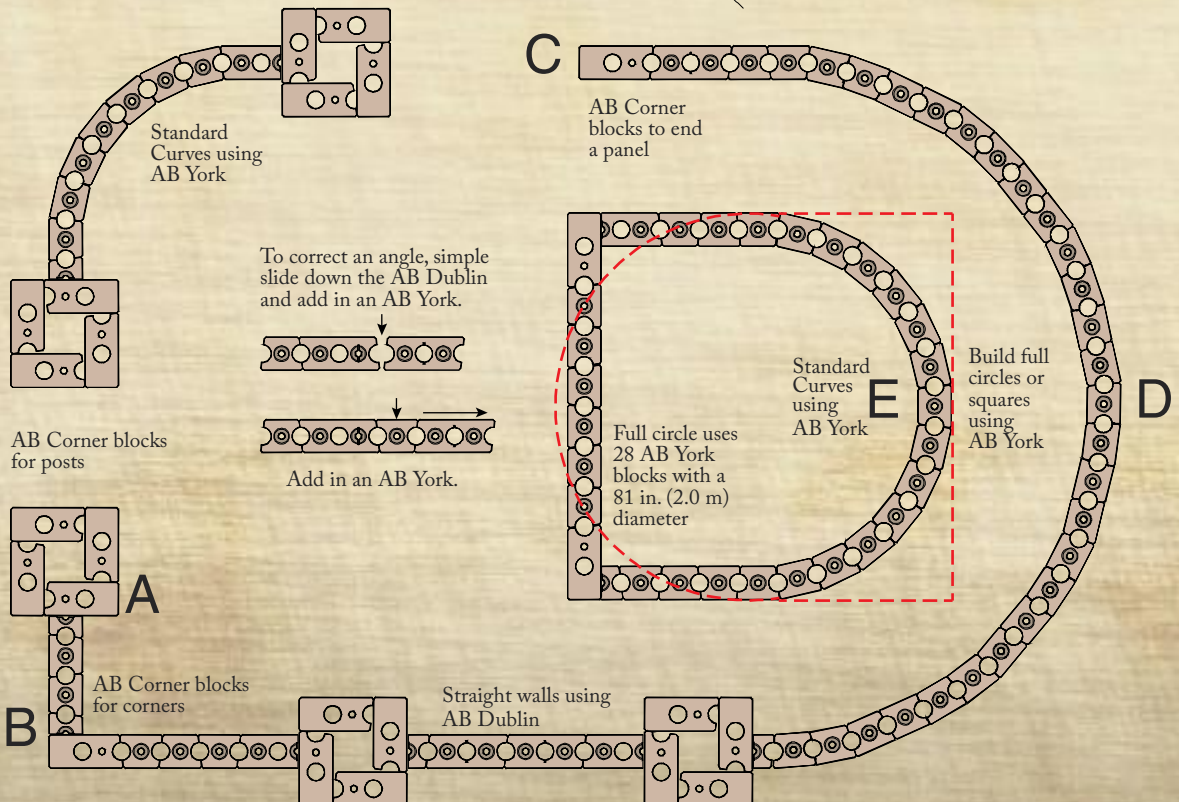

allanblock.com

## Combining Posts and Panels

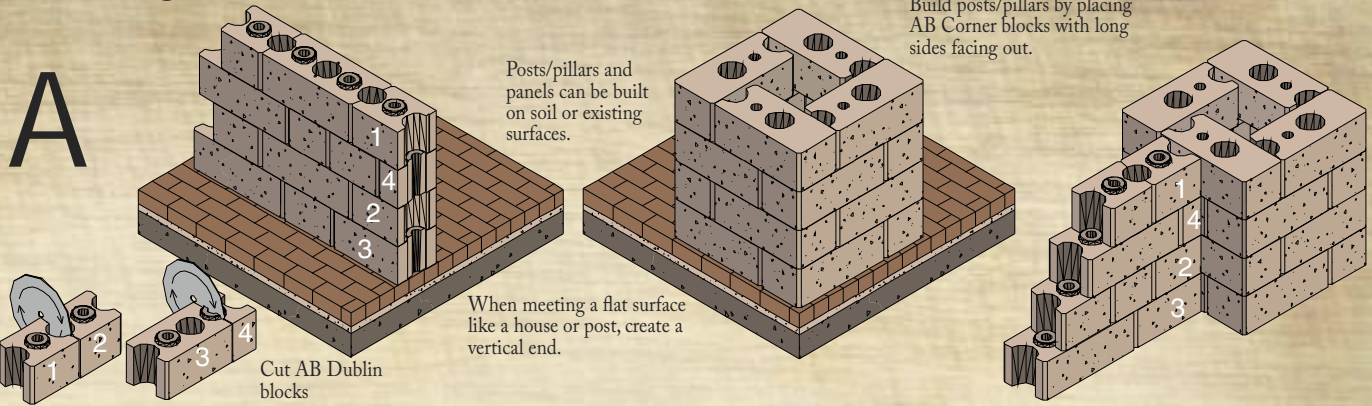

## Build Corners

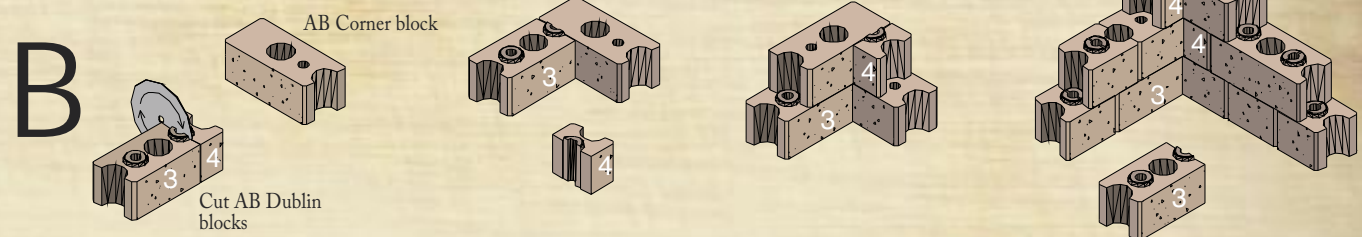

## Finish with Step Downs (2 options shown)

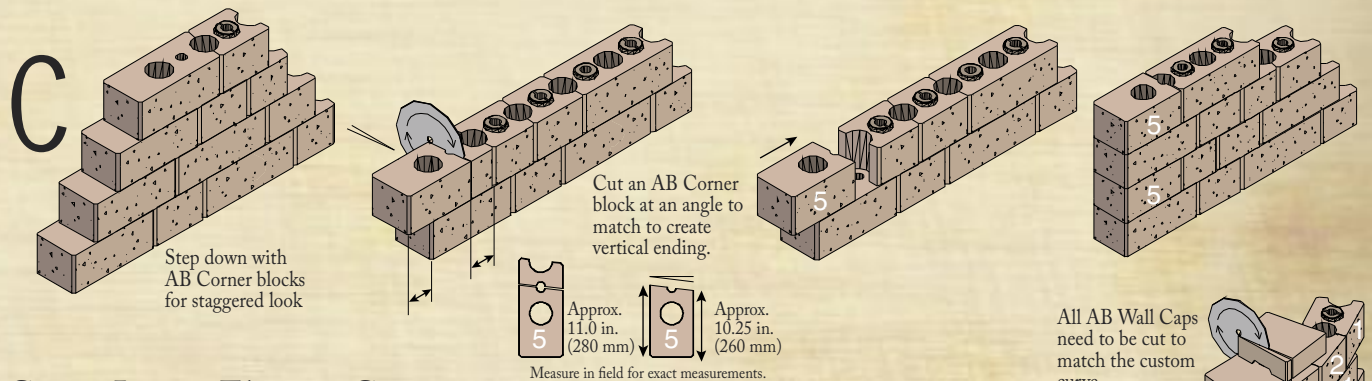

## Create Larger Flowing Curves

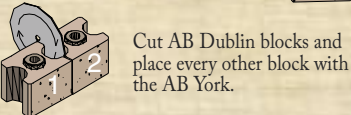
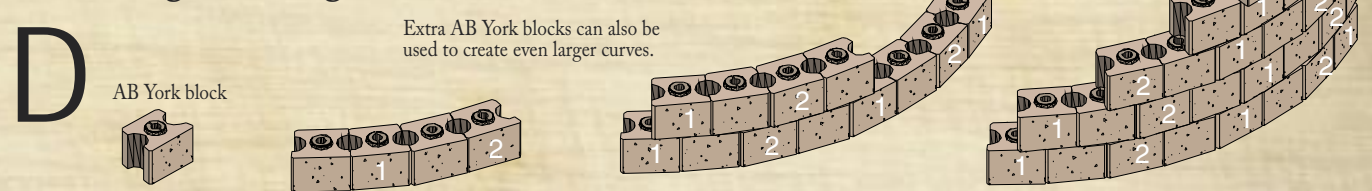

Blending the cut AB Dublin and AB York blocks allows any custom curves to be created.

- Step 1:** While building the first two courses at the same time, use a dead blow hammer to adjust transition and gaps between units to achieve desired curve. It may be necessary to slightly increase gaps to obtain desired curve.
- Step 2:** When units appear not to fit together, remove an AB York and replace with a half AB Dublin, oriented the correct direction, to overcome the tight or loose condition to obtain the desired curve.
- Step 3:** When using the Options A, B, C or D you may find that patterns do not always repeat. Use any combination of these patterns to overcome tight or loose fit conditions.

## Standard Curves

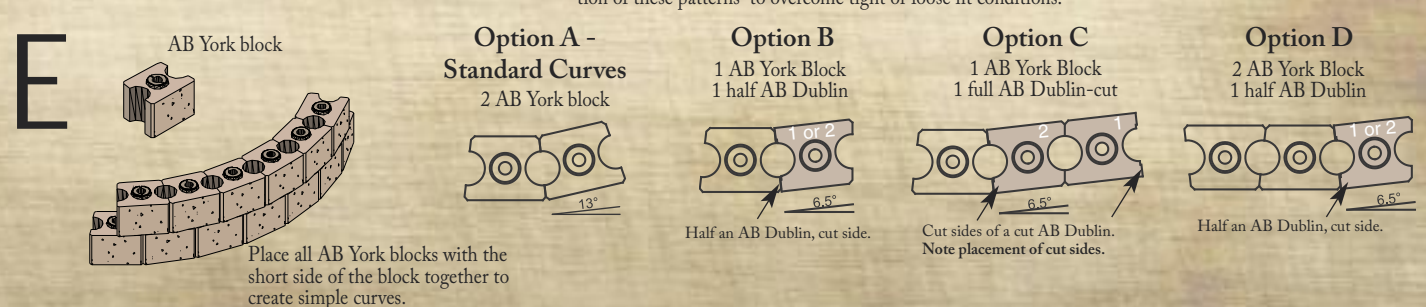



## AB Fence® System

The perfect choice for fencing and sound barrier applications between homes, businesses or along roadways.



*Allan Block has many other products available to help with your landscaping needs. Visit our website at [allanblock.com](http://allanblock.com) for the latest information, product availability, color selection and more.*



## AB Fieldstone Collection®

Our Eco-Friendly “Green” retaining wall offers the look of natural stone in a lightweight and user-friendly product. With different facing textures and colors available, you can find the perfect “Natural” look for your project.



## AB® Retaining Walls

Available in two different textures the AB® or AB Europa® Collection retaining wall blocks are perfect for any size of project. Use them with the AB Courtyard Collection® with matching colors and textures to create outdoor living areas that will compliment each other perfectly.



Available At:

