

TufTile[®]

ADA DETECTABLE WARNING PRODUCTS

Cast Iron

Radius

Wet-Set Cast Iron

ADA COMPLIANT • DURABLE • REPLACEABLE



www.TufTile.com

CAST IRON TILES WET-SET

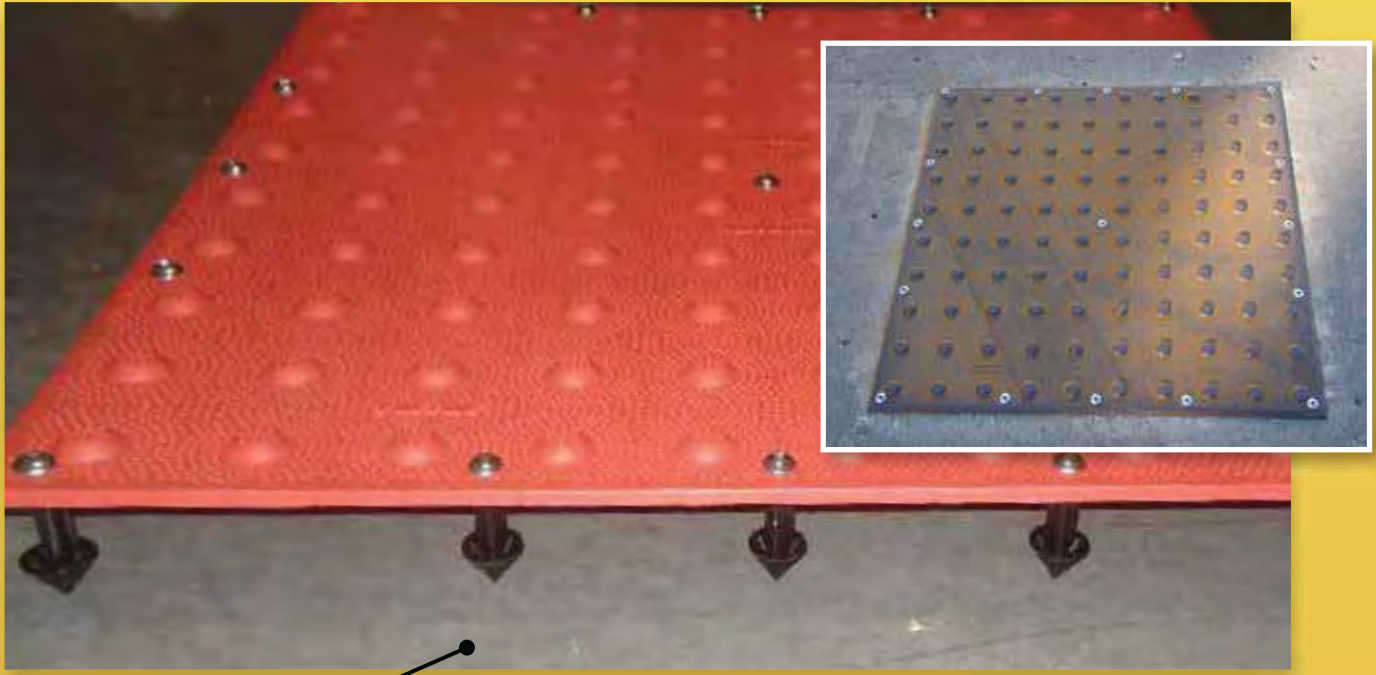

Tiles shipped with
anchors installed

Wet-Set Tiles

Great for use in areas where heavy tile abuse is possible including areas subject to snowplowing.

Durable rust resistant finish on all tile color options.

Durable solid cast iron construction complies with "Buy American" domestic content requirements.

ADA compliant wet & dry slip-resistant surface.

Cast iron wet-set tiles are for new construction.

Unique "umbrella" style anchors lock tile securely into concrete without displacing aggregate.

Uniform tile underside eliminates trapping air during installation.

TUFTILE® TACTILE IS ADAAG / PROWAG / CA TITLE 24 COMPLIANT

PAT. NO. US D691,743 S

CAST IRON TILES

Durable Cast Iron complies with "Buy America" domestic content requirement
WET-SET (REUSABLE)

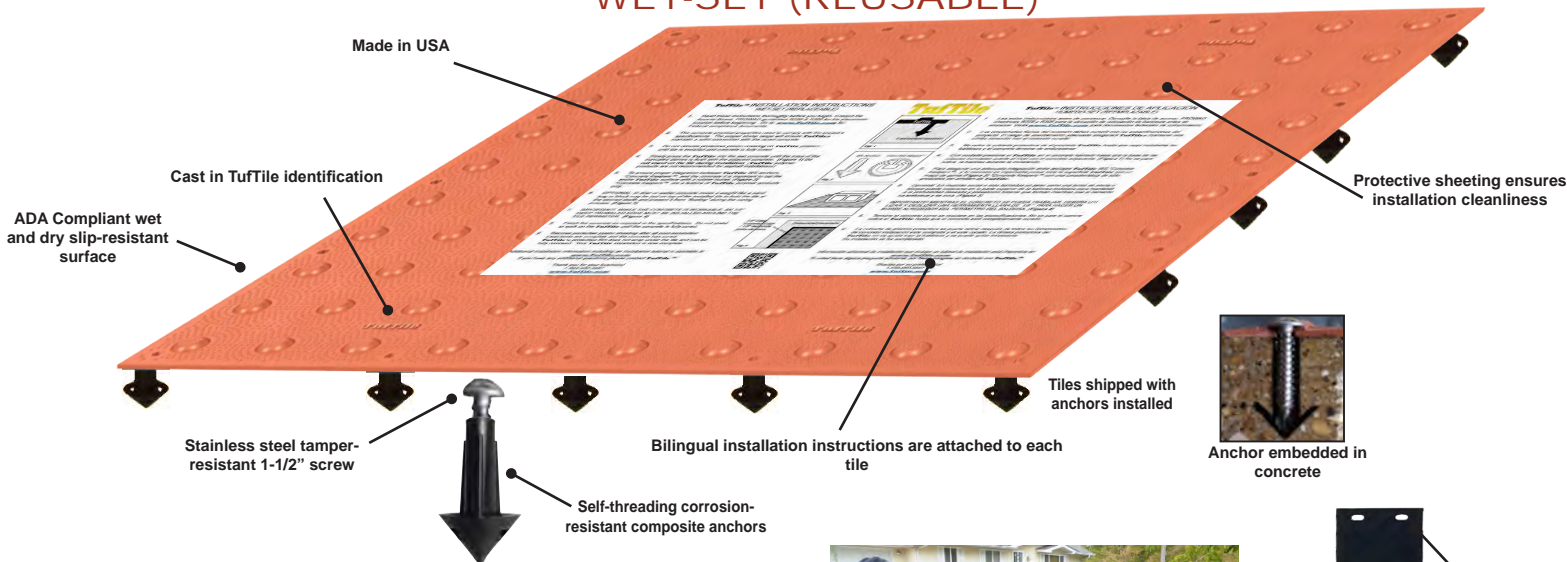

Powder coat color includes zinc-rich epoxy primer base and durable UV resistant finish.



Simplify Wet-Set installation by connecting panels.

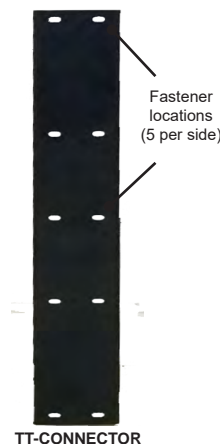

TT-CONNECTOR

Cast Iron Sizes	Cast Iron Weight
24" x 12"	19 lbs
24" x 24"	37 lbs
24" x 30"	46 lbs

CAST IRON RADIUS TILES

Radius Wedge colors match corresponding Cast Iron tiles

Wedges are sized per the radius of the arc.

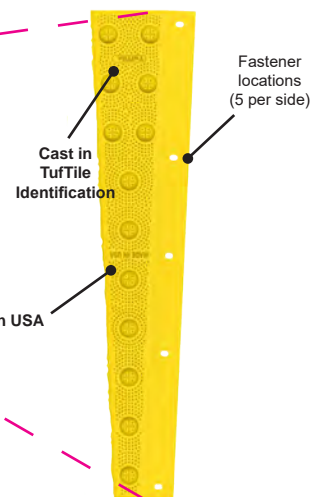
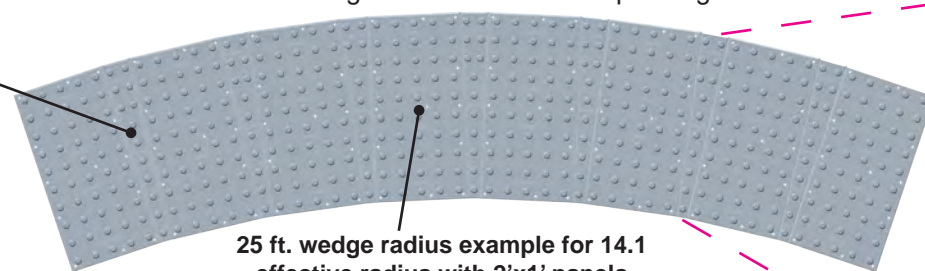

25 foot radius wedge (Cast Iron, single flange)

EFFECTIVE RADIUS SIZES				
Wedge	Weight	Radius	with 2' x 2' Panels	with 2' x 1' Panels
15R	11.8 lbs	15 Foot	15 Foot Radius	8.8 Foot Radius
20R	10.5 lbs	20 Foot	20 Foot Radius	11.1 Foot Radius
25R	9.3 lbs	25 Foot	25 Foot Radius	14.1 Foot Radius
30R	8.5 lbs	30 Foot	30 Foot Radius	16.8 Foot Radius

TufTile® ADA Tiles have a 5-Year Limited Warranty – see website or contact customer service.

TUFTILE® TACTILE IS ADAAG / PROWAG / CA TITLE 24 COMPLIANT

PAT. NO. US D691,743 S

Cast Iron Packaging Design



Packaged 26 per skid. With anchor supports between each panel.



Panels come with bi-lingual installation instructions and protective sheeting on each tile.



Corner blocking protects the outside edges from damage during shipping.



Skid and panels are wrapped in protective film with label affixed to the side.

TufTile®

ADA TACTILE (CAST IRON) PRODUCTS

WET-SET

- 24" x 12"
- 24" x 24"
- 24" x 30"

- Brick Red
- Colonial Red
- Yellow
- Black
- Patina (natural)
- Dark Gray

Anchors Attached

Cast Iron Panels packaged:

Panel Size	24"x12"	24"x24"	24"x30"
Units/Skid	52	26	26
Weight	1023	1023	1270
Dimensions	26"x49"	26"x49"	32"x49"

TufTile Radius Calculator

Reset Values

Feet/Inches
 Metric

Polymer Cast Iron

Radius Length feet

Have Radius Have Height

Chord Length feet

Have Chord Length Have Arc Length

Arc Length Segment Length (tile + wedge) Arc Overrun Variance

Recommended Tile Size
 Recommended Wedge Size

Quantity
 Quantity

Calculate

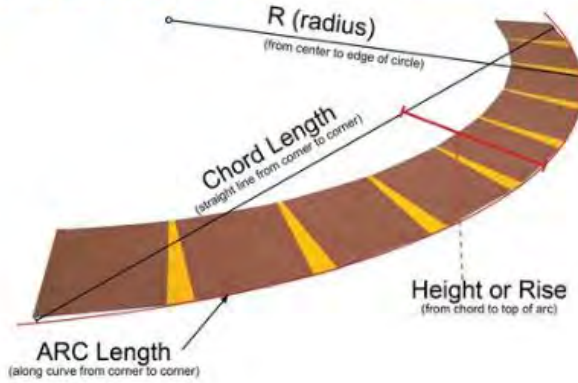

Enter values in the 2 fields provided (Radius Length and Chord Length) then click the 'Calculate' button to create the estimate for your Radius installation. You can enter the Height or Rise in lieu of the Radius Length. Arc Length can be used as an alternative to the Chord as well. The recommended Tile Size, Wedge Size and their respective Quantities will display in the space provided.

The Metric option will expect the lengths to be entered in Meters.

Polymer vs Cast Iron will make use of the 24"x36" tiles or 24"x30" respectively as required.

The values 'arc length', 'segment length', 'arc overrun' and 'variance' are informational.

Arc Length is calculated when the chord length is given. Segment Length is known by adding the top edge lengths of 1 selected Tile and Wedge. Arc overrun is the remainder when the Arc Length is different than the sum of the Tiles and Wedges. Variance occurs when the Radius calculated is different than the Radius made from the suggested components. The variance amount is the distance between those two values.

The Size change warning line will display when the program calculates an 'Arc overrun' that is negative. In the case when a smaller tile will leave less extra radius it recommends that instead of just adding another equal width tile. So if the job calls for 7 24"x24" tiles and 7 wedges and it leaves less than 14 inches of remaining radius, it tells the user to order 1 24"x12" tile instead of another 24"x24". The same goes for 30" and 36" wide tiles where it can substitute a 24"x12" or 24"x24" as required. This is only a suggested solution.

Our Radius calculator is provided as a reference to help you estimate the amount of material you need for your project. This calculator provides an ESTIMATE.

*Coverage is affected by a number of factors. ** In order for us to ensure that you have adequate material for your job, please round up to the nearest foot.*

24" X 12" WET SET

CAST IRON DETECTABLE WARNING TILE 2.350 DOME SPACING

(REPLACEABLE)

TEL 888-960-8897

FAX 847-550-8004

www.tuftile.com

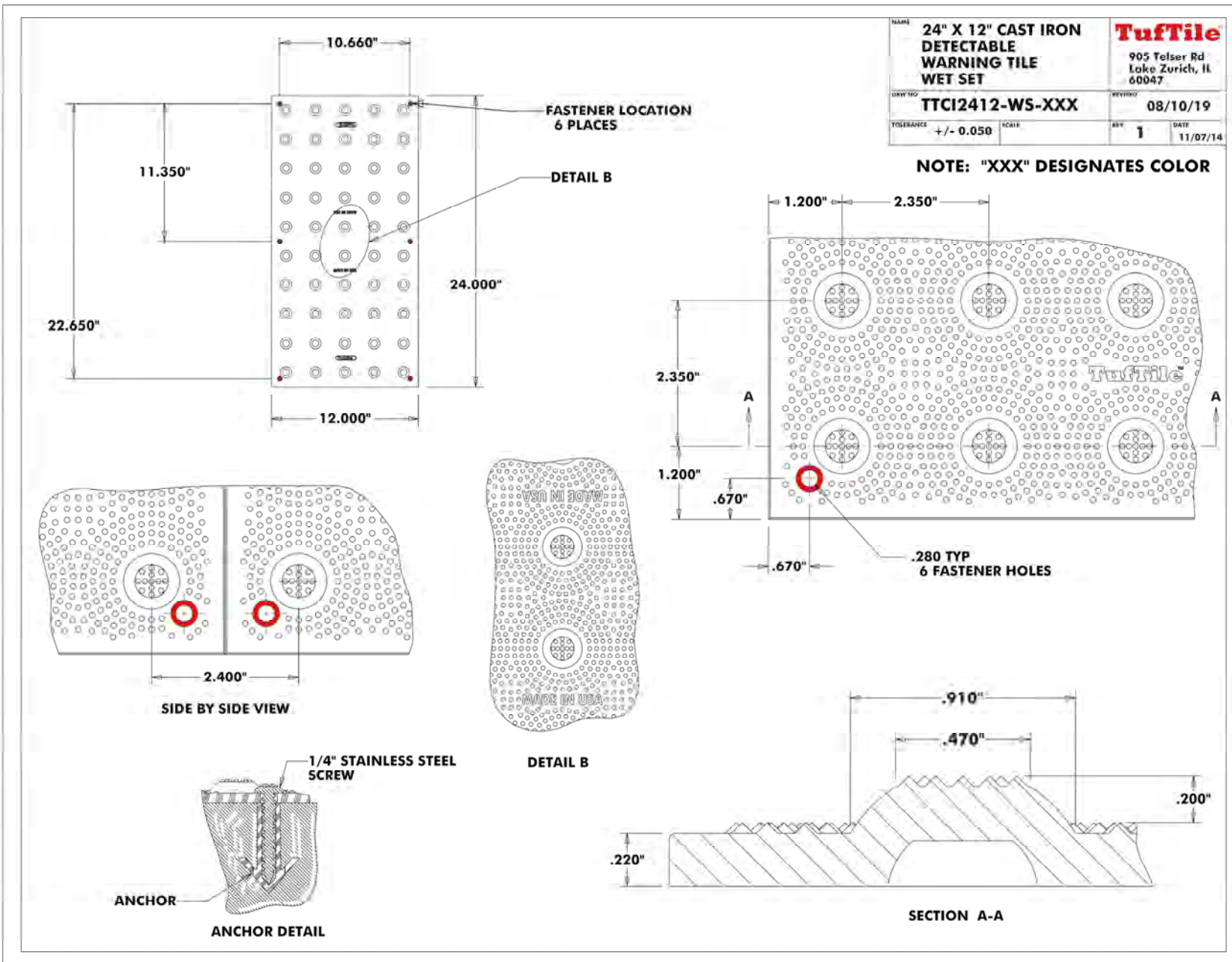

24" X 24" WET SET

CAST IRON DETECTABLE WARNING TILE 2.350 DOME SPACING

(REPLACEABLE)

TEL 888-960-8897

FAX 847-550-8004

www.tuftile.com

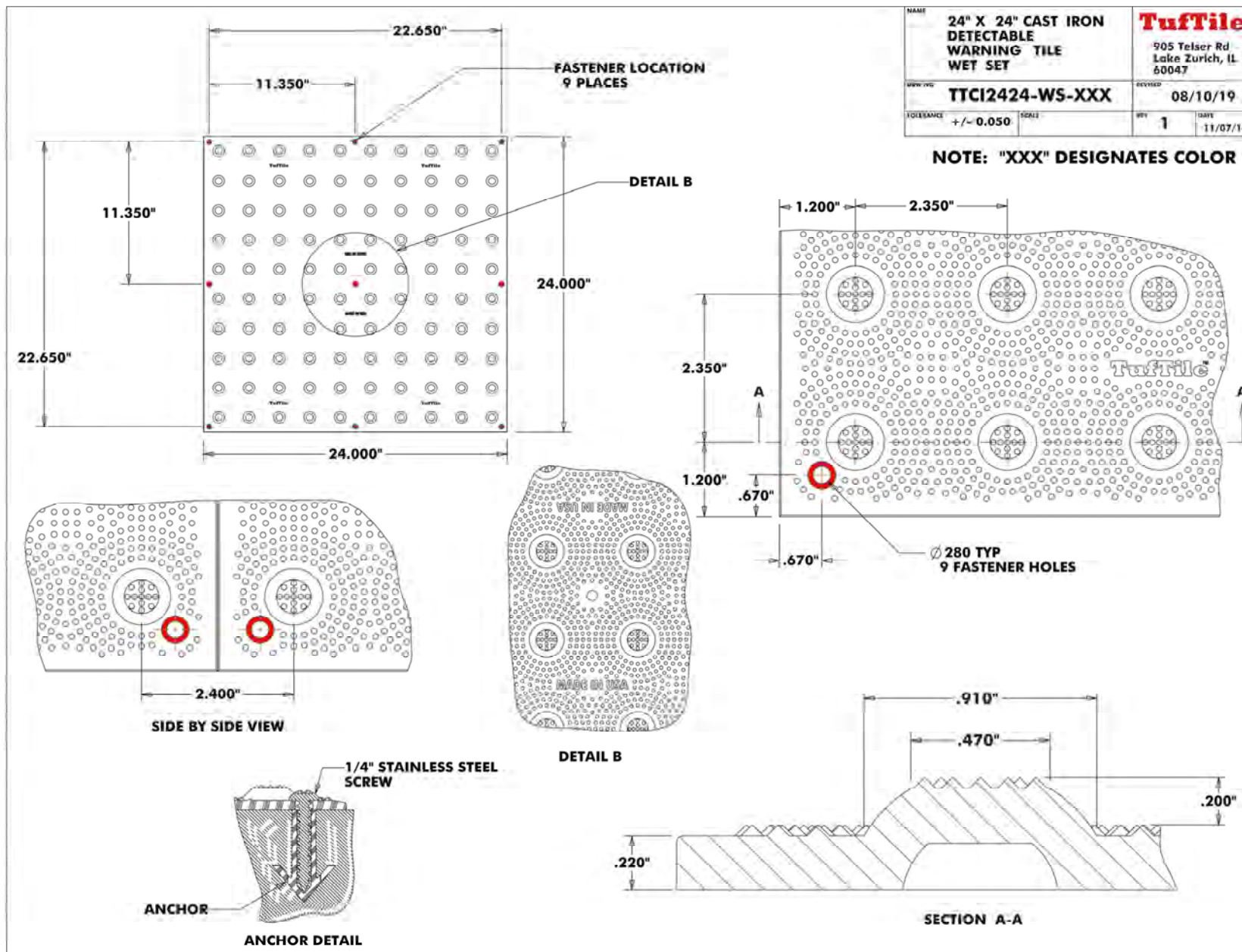

24" X 30" WET SET

(REPLACEABLE)

CAST IRON DETECTABLE WARNING TILE 2.350 DOME SPACING

TEL 888-960-8897

FAX 847-550-8004

www.tuffile.com

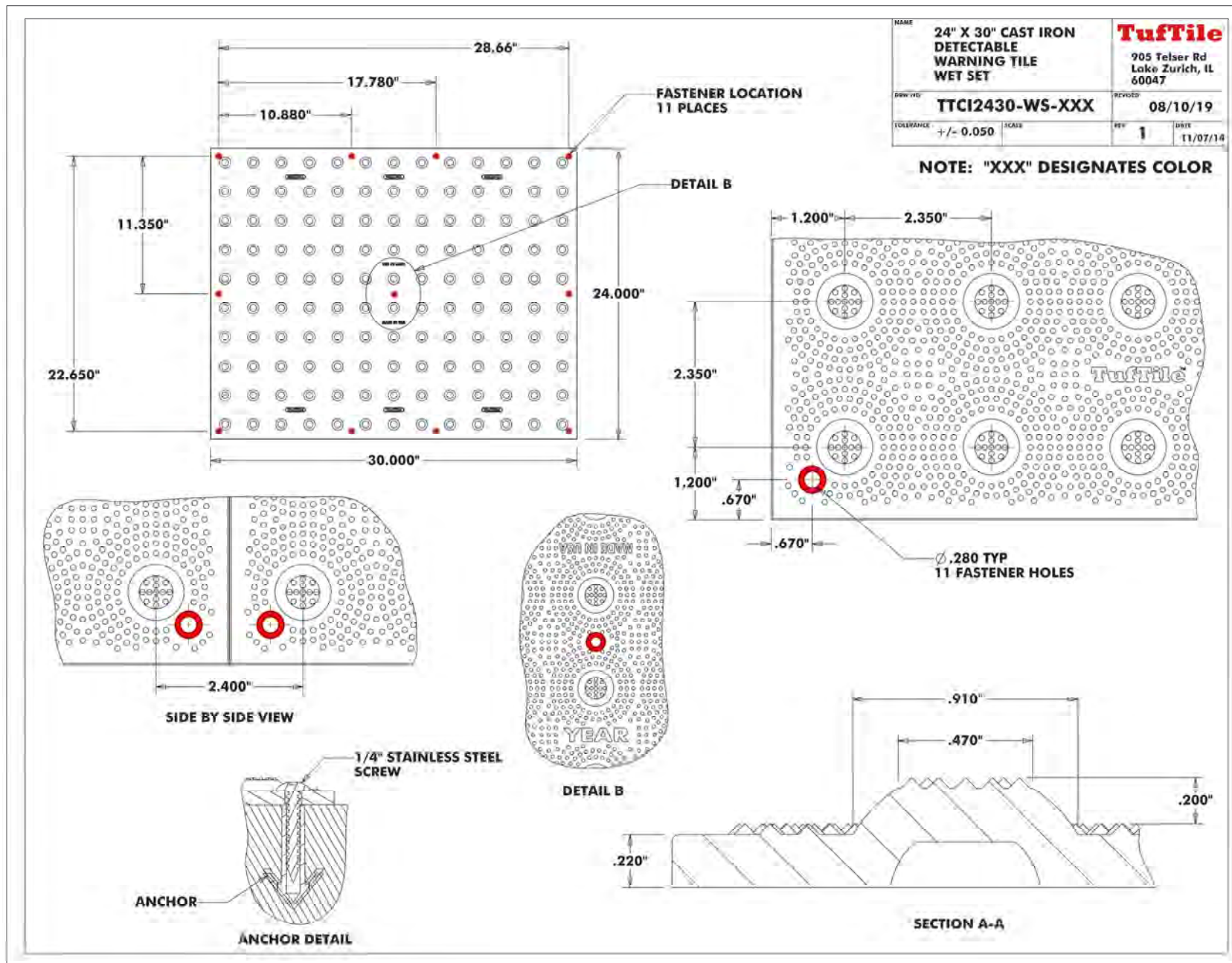

15' WET SET

(REPLACEABLE)

CAST IRON DETECTABLE WARNING RADIUS—WEDGE TILE

TEL 888-960-8897

FAX 847-550-8004

www.tuftile.com

NAME 15' CAST IRON WET-SET DETECTABLE WARNING RADIUS - WEDGE TILE		Tuftile 905 Telsler Rd Lake Zurich, IL 60047	
DWG NO TTCI15RW-WS-XXX		REVISED 08/10/19	
TOLERANCE +/- 0.050	SCALE	REV 1	DATE 11/07/14

NOTES: "XXX" DESIGNATES COLOR

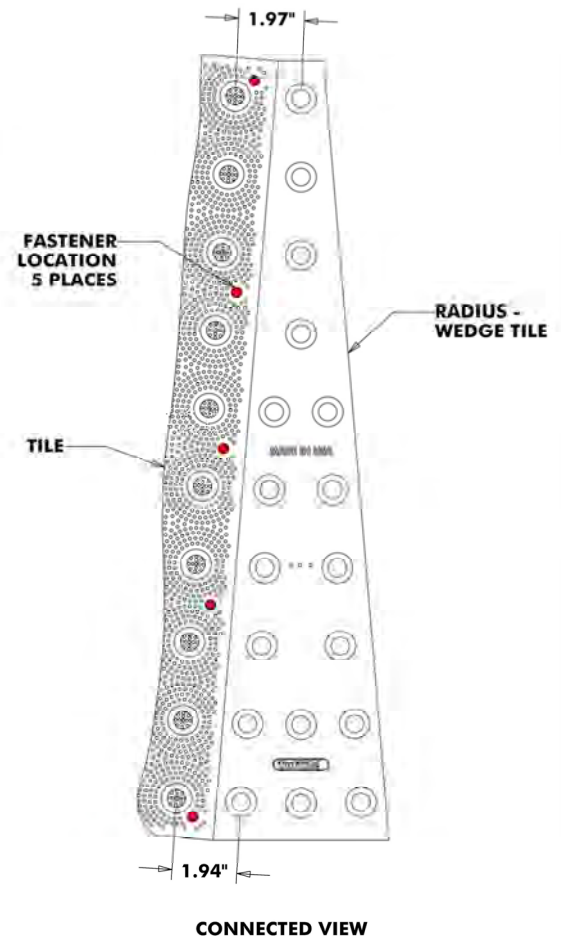
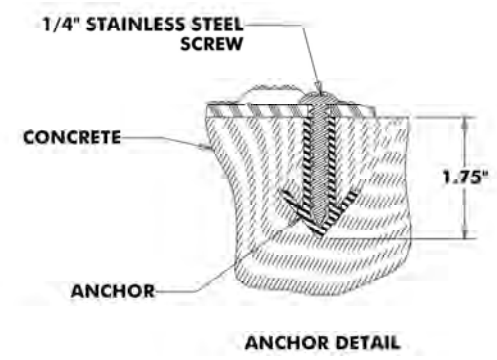
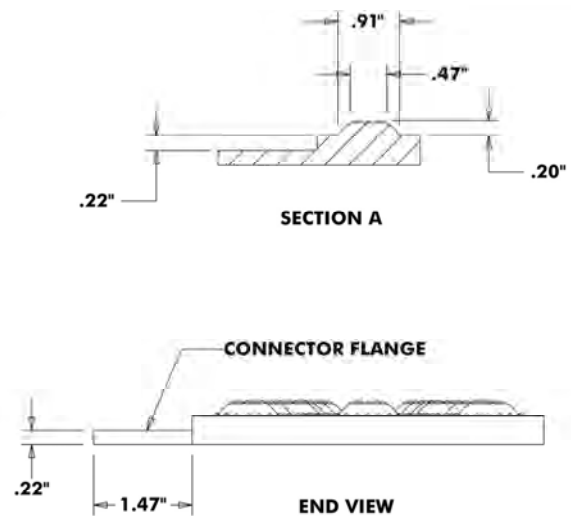
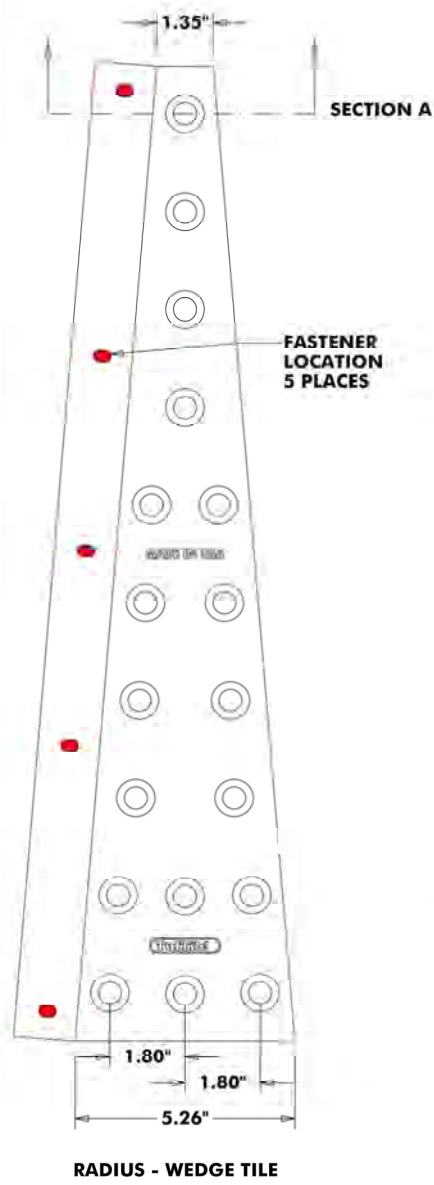

20' WET SET

(REPLACEABLE)

CAST IRON DETECTABLE WARNING RADIUS—WEDGE TILE

TEL 888-960-8897

FAX 847-550-8004

www.tufile.com

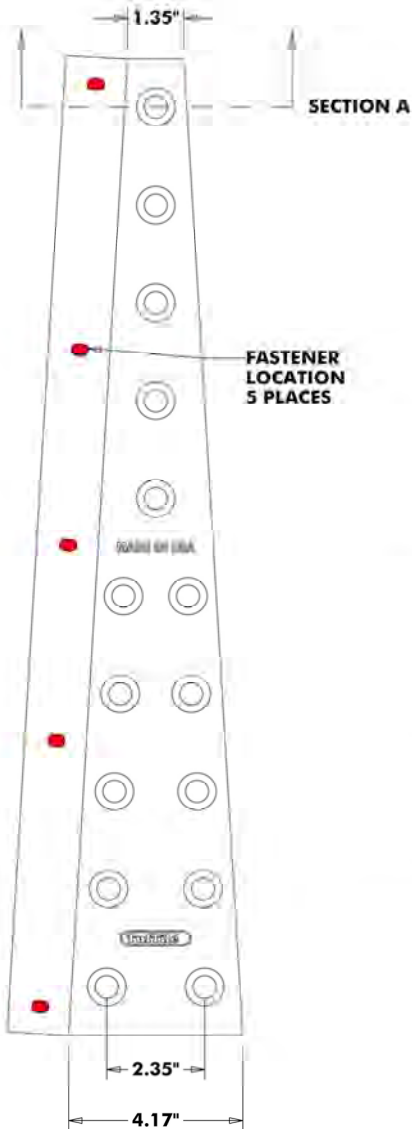

RADIUS - WEDGE TILE

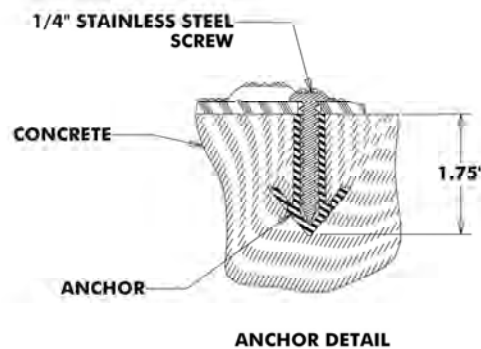
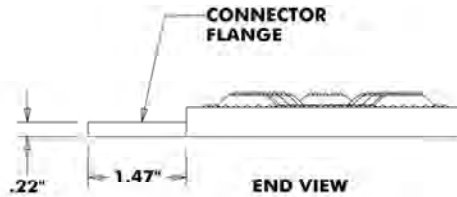
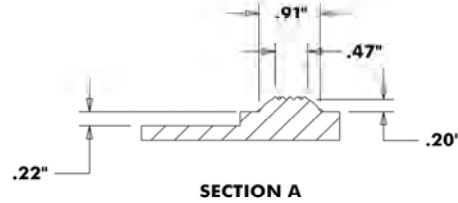

ANCHOR DETAIL

NAME 20' CAST IRON WET-SET DETECTABLE WARNING RADIUS - WEDGE TILE		TuFile 905 Telser Rd Lake Zurich, IL 60047	
REV NO TTCI20RW-WS-XXX	REVISED 08/10/19	REV 1	DATE 11/07/14
TOLERANCE +/- 0.050	SCALE		

NOTES: "XXX" DESIGNATES COLOR

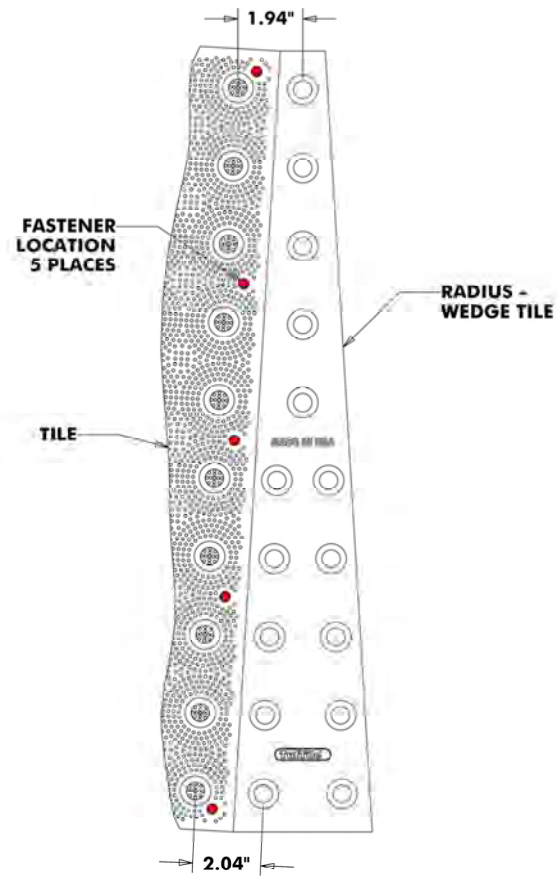

CONNECTED VIEW

25' WET SET

(REPLACEABLE)

CAST IRON DETECTABLE WARNING RADIUS—WEDGE TILE

TEL 888-960-8897

FAX 847-550-8004

www.tufile.com

NAME 25' CAST IRON WET-SET DETECTABLE WARNING RADIUS - WEDGE TILE		TuFile™ 905 Telser Rd Lake Zurich, IL 60047	
DSW NO TTCI25RW-WS-XXX	REVISED 08/10/19	REV 1	DATE 11/07/14
TOLERANCE +/- 0.050	SCALE		

NOTES: "XXX" DESIGNATES COLOR



SECTION A

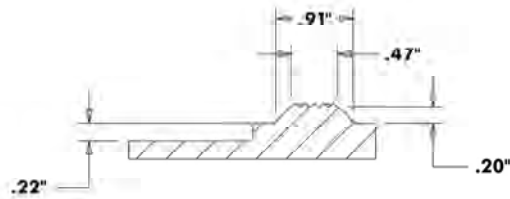

SECTION A

FASTENER
LOCATION
5 PLACES

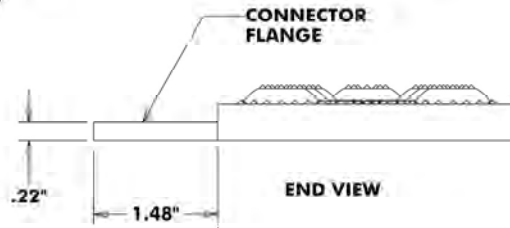

END VIEW

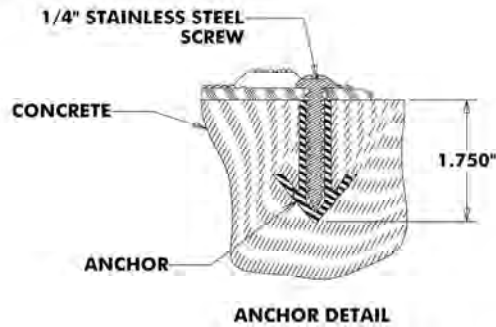

ANCHOR DETAIL

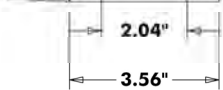

RADIUS - WEDGE TILE

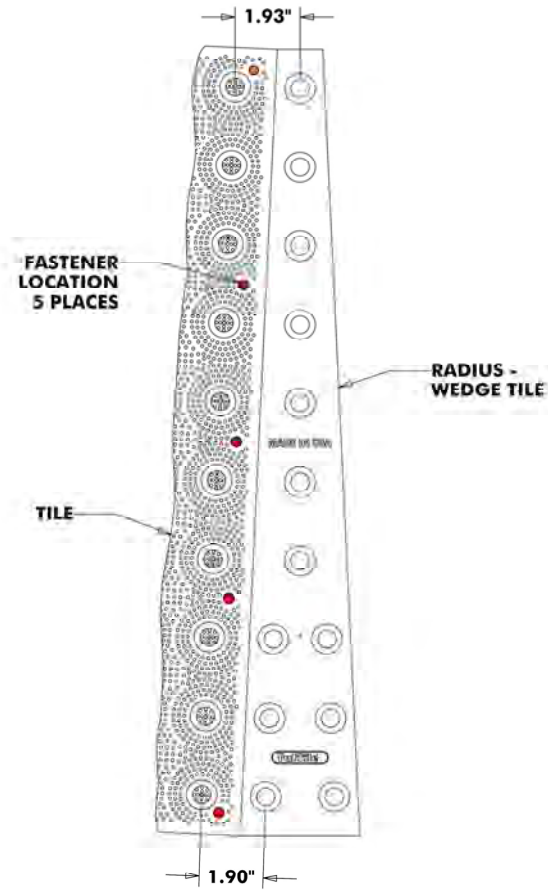

CONNECTED VIEW

30' WET SET

(REPLACEABLE)

CAST IRON DETECTABLE WARNING RADIUS—WEDGE TILE

TEL 888-960-8897

FAX 847-550-8004

www.tuftile.com

NAME 30' CAST IRON WET-SET DETECTABLE WARNING RADIUS - WEDGE TILE		TuFile™ 905 Teiser Rd Lake Zurich, IL 60047	
DSW NO TTCI30RW-WS-XXX		REVISED 08/10/19	
TOLERANCE +/- 0.050	SCALE	REV 1	DATE 11/07/14

NOTES: "XXX" DESIGNATES COLOR

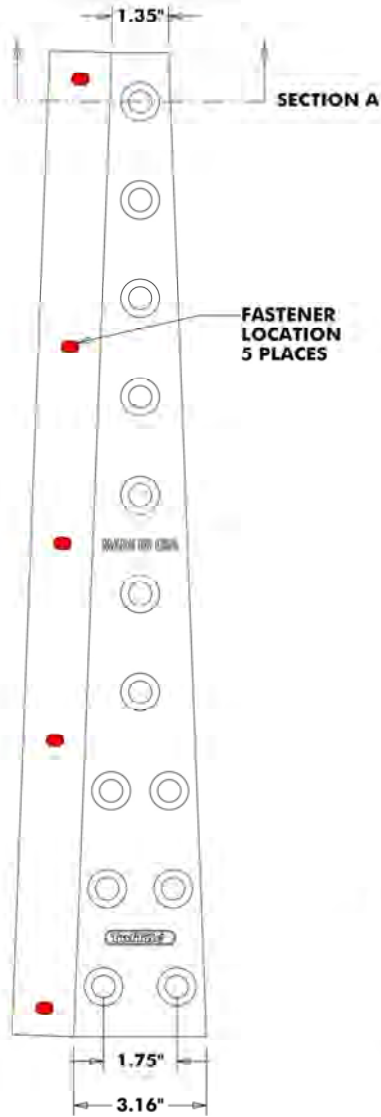

RADIUS - WEDGE TILE

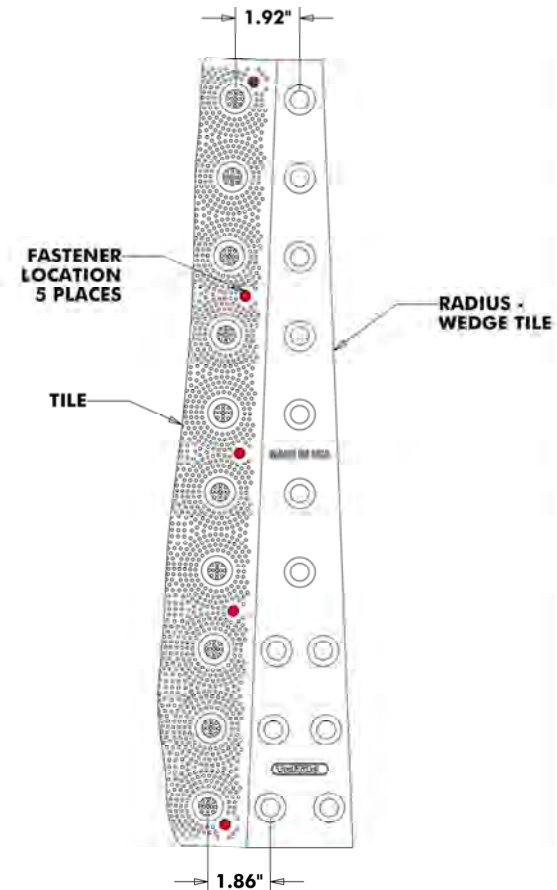
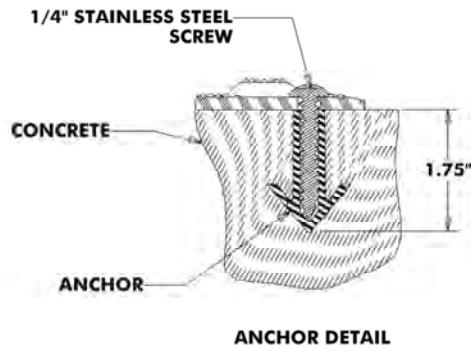
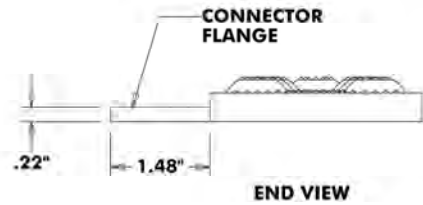
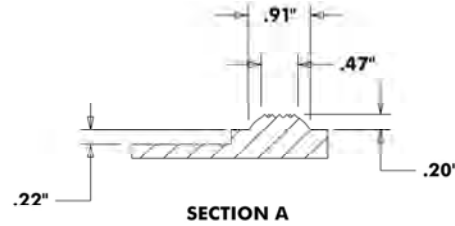

CONNECTED VIEW



WAUPACA FOUNDRY, INC.

1955 Brunner Drive

P.O. Box 249

Waupaca, WI 54981

PHONE (715) 258-6611

WEB WaupacaFoundry.com

July 26, 2017

TUF-TITE, INC.
INPRES, INC.
TUFTILE, INC.
1200 Flex Court
Lake Zurich, IL 60047

RE: Waupaca's Certification for Buy America Act.

Ted Meyers

All castings produced by Waupaca Foundry, Inc. for Tuf-tite Inc. are MELTED, POURED, AND MANUFACTURED EXCLUSIVELY at one of our six facilities located in Waupaca and Marinette, Wisconsin, Tell City, Indiana, or Etowah, Tennessee. Under the various "Buy American" definitions, the following are those that we comply with:

- American Recovery and Reinvestment Act of 2009, Section 1605 – Buy America
- Federal Aviation Administration, 49 U.S.C. § 50101
- Federal Highway Administration, 23 U.S.C. § 313 – Buy America; 23 C.F.R. § 635.410
- Federal Transit Administration, 49 U.S.C. § 5323(j); 49 C.F.R. Part 661

Please do not hesitate to contact us at any time with any questions or concerns that you may have.

Thank you,

Darrell Oligney

A handwritten signature in black ink that reads "Darrell Oligney".

Senior Customer Service Manager



TufTile® INSTALLATION INSTRUCTIONS WET-SET (REPLACEABLE)

1. Read these instructions thoroughly before you begin. Consult the Access-Board, PROWAG guidelines R208 & R305 for tile placement location before beginning. Go to www.TufTile.com for Federal compliance documents.
2. The concrete physical properties need to comply with the project's specifications. The proper slump range will ensure **TufTiles** maintain a solid connection with the cured concrete.
3. For Radius or Connected Tiles, see below. For normal tile install, do not remove protective plastic covering from **TufTile** until it's installed and concrete is fully cured.
4. Slowly press the **TufTile** into the wet concrete until the base of the truncated domes is flush with the concrete. **(Figure 1) Do not stand on the tile during installation.** (**TufTile** polymer products are not recommended for asphalt installations)
5. To ensure proper integration between **TufTile** WS anchors, *Concrete Keepers™, and the concrete it is important to tap the entire **TufTile** surface with a rubber mallet. **(Figure 2)** *Concrete Keepers™ are a feature of **TufTile** polymer products only.
6. OPTIONAL: In drier or wetter concrete mixes a weight like a sand bag or block may be laid on top of the installed tile to hold the tile at the desired depth and prevent it from "floating" during the curing process. **(Figure 3)**
7. IMPORTANT! WHILE THE CONCRETE IS WORKABLE, AN 1/8" DEEP TROWELED EDGE MUST BE INSTALLED AROUND THE TILE PERIMETER. **(Fig. 4)**
8. Finish the concrete as required in the specifications. Do not stand or walk on the **TufTile** until the concrete is fully cured.
9. Remove protective plastic sheeting after all post-installation treatments are complete and the concrete has cured. **TufTile's** protective film does not wrap under the tile and can be fully removed. Your **TufTile** installation is now complete.

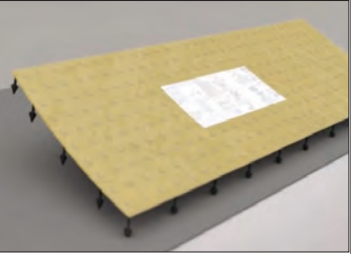

Fig. 1



Fig. 2

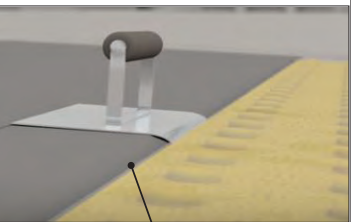

Fig.3

1/8" Deep Troweled Edge

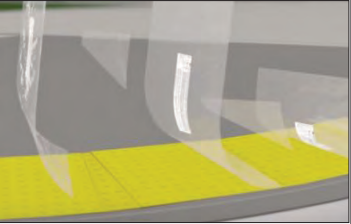
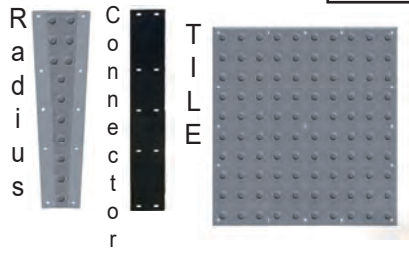

Fig. 4



Connected Radius Example



Radius or Connected **TufTile**® Installation

Instead of Step 3 above, do the following:

3. Peel back the protective coating on the tile edges.
- 3a. Remove anchors from edges that join.
- 3b. Insert Radius or Connector part between the tiles.
- 3c. Re-install anchors through tile and Radius or Connector.
- 3d. Locate the complete surface in position over wet concrete

Resume installation at Step 4 above

Additional installation information including an installation tutorial is available at www.TufTile.com

If you have any additional questions please contact **TufTile**®

Thank you for your business!
1-888-960-8897
www.TufTile.com

TufTile® INSTRUCCIONES DE APLICACIÓN HÚMEDO-SET (REEMPLAZABLE)

1. Lea estas instrucciones antes de comenzar. Consulte la tabla de acceso, PROWAG directrices R208 y R305 para la ubicación de colocación de baldosas antes de empezar. Visita www.TufTile.com para documentos federales de cumplimiento.
2. Las propiedades físicas del concreto deben cumplir con las especificaciones del proyecto. El rango de asentamiento adecuado asegurará **TufTiles** mantener una sólida conexión con el concreto curado.
3. Para radio o azulejos conectados, ver abajo. Para baldosas de instalación normal, no retire la cubierta plástica protectora de **TufTile** hasta que esté instalado y el hormigón esté completamente curado.
4. Con cuidado presione el **TufTile** en el concreto húmedo hasta que la base de las cúpulas truncadas quede al nivel con el concreto adyacente. (**Figura 1**) No se pare sobre la baldosa durante la instalación.
5. Para asegurar una adecuada integración entre anclajes **TufTile** WS,*Concrete Keepers™, y lo concreto es importante pulsar toda la superficie **TufTile** con un mazo de goma. (**Figura 2**) *Concrete Keepers™ son una característica de sólo productos del almidón de **TufTile**.
6. Opcional: En mezclas secas o más húmedas un peso como una bolsa de arena o blo que puede colocarse en la parte superior de la baldosa instalada para mantener a la profundidad deseada y prevención flotante que forman mientras que el cemento se endurece y se cura. (**Figura 3**)
7. **IMPORTANTE! MIENTRAS EL CONCRETO SE PUEDA TRABAJAR, DEBERA UTILIZAR Y DESLIZAR UNA HERRAMIENTA LLANA DE 1/8" PARA HACER UN BORDE ALREDEDOR DEL PERÍMETRO DEL BALDOSA. (Figura 4)**
8. Termine el concreto como se requiere en las especificaciones. No se pare ni camine sobre el **TufTile** hasta que el concreto esté completamente curado.
9. La cubierta de plástico protectora se puede retirar después de todos los tratamientos de concreto instalación este completa y el este curado. La lámina protectora del **TufTile** no se ajusta bajo la baldosas y se puede quitar totalmente. Su instalación se ha completado.

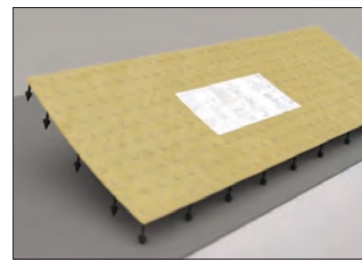

Fig. 1



Fig. 2



Fig.3 1/8" del borde profundo llana

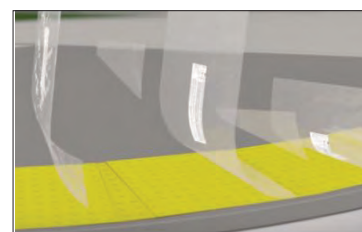
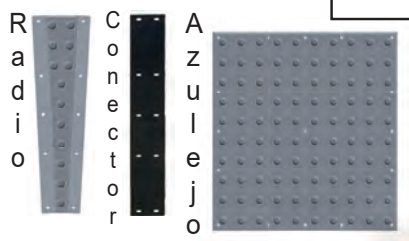

Fig. 4



Ejemplo radio Conectado



Instalación de radio o conectados **TufTile**®

En lugar de paso 3, haga lo siguiente:

3. Remueva la capa protectora en los bordes de los azulejos.
- 3a. Retire los anclajes de los bordes que se unen.
- 3b. Asemble el conector o al radio entre los TufTiles.
- 3c. Volver a instalar los anclajes a través de baldosas y Radio o Conector.
- 3d. Localice la superficie montaje completa en posición sobre el hormigón húmedo.

Reanudar la instalación en el paso 4 anterior

Información adicional de instalación que incluye un tutorial de instalación está disponible en www.TufTile.com

Si usted tiene alguna pregunta adicional, por favor, póngase en contacto con **TufTile**®.

Gracias por su preferencia!

1-888-960-8897

www.TufTile.com

MATERIAL SAFETY DATA SHEET (MSDS)

SECTION I: MATERIAL IDENTIFICATION
CHEMICAL FAMILY: Gray Iron
MANUFACTURER: Iron (Fe)
CONTACT INFORMATION: **Thyssen Krupp-Waupaca, Inc. Waupaca, WI 54981**
TufTile™ 1200 Flex Court, Lake Zurich, IL 60047
Ph: (888) 960-8897

SECTION II: COMPOSITION/INFORMATION ON INGREDIENTS
Hazardous Components: None in solid form
Composition: Carbon (C), Chromium (Cr), Copper (Cu), Iron (Fe), Nickel (Ni), Silicon (Si), Tin (Sn)
Melting Temperature: 2350 Degrees Fahrenheit

SECTION III: PHYSICAL CHARACTERISTICS
Emergency Overview: This material is NOT HAZARDOUS by OSHA Hazard
Appearance and Odor: Solid Mass, No Odor
Specific Gravity: 7.86
Freezing Point: N/A
Solubility in Water: Insoluble
% Volatile by Volume: N/A
Boiling Point: 5000F
pH: N/A

SECTION IV: FIRE AND EXPLOSION INFORMATION
Flammability: Not Flammable
Means of Extinction: N/A
Special Procedures: None
Explosion Data: None Known
Sensitivity of Mechanical impact: None
Hazardous Combustion: None Known
Auto ignition Temp: N/A
Sensitivity to Static: N/A

SECTION V: HEALTH HAZARD DATA
Permissible Exposure: N/A for product (See Section II above)

SECTION VI: REACTIVITY DATA
Chemical Stability: Yes
Reactivity: N/A

SECTION VII: SPILL OR LEAK PROCEDURES
Spill: None (Solid Mass Product)
Waste Disposal: Recover or Recycle if possible

SECTION VIII: PROTECTIVE EQUIPMENT TO BE USED:
Protective Gloves: Wear resistant gloves
Eye Protection: Wear safety glasses with side shields

SECTION IX: LEGAL DISCLAIMER
The above information is based on the data of which we are aware and is believed to be correct as of the date hereof. Since this information may be applied under conditions beyond our control and with which may be unfamiliar and since data made available subsequent to the date hereof may suggest modifications of the information, we do not assume any responsibility for the results of its use. This information is furnished upon condition that the person receiving it shall make his own determination of the suitability of the material for his particular purpose.™

PHYSICAL CHARACTERISTICS – CAST IRON

DOME GEOMETRY

ADA (R305.1.1) specifies truncated domes shall have a base diameter of 0.9" minimum, a top diameter of 50% of the base diameter minimum, and a height of 0.2".

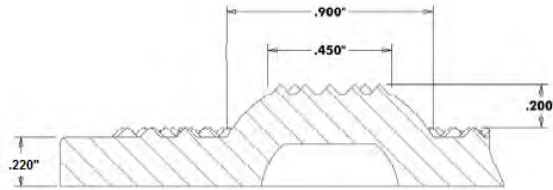

DOME SPACING

ADA (R305.1.2) specifies truncated domes shall have a center-center of 1.6" to 2.4"

In-Line truncated domes comply with all ADA Specifications

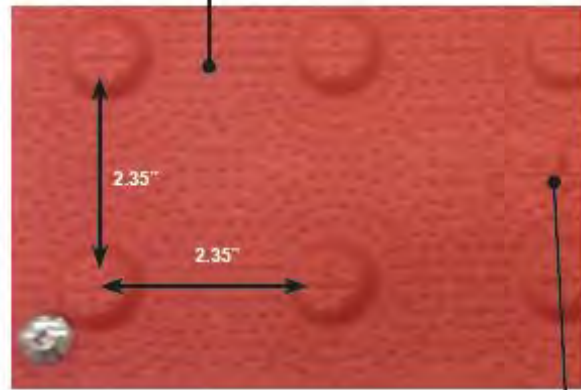

ADA Compliant wet and dry slip-resistant surfaces

Manufacturer identification

CAST IRON WET-SET

Material – Gray Iron

ASTM C 1028	Slip Resistance	Dry-.948 Wet-1.099
ASTM A 48	Tensile Strength	35,900 psi
ASTM C 501-84	Abrasion Resistance	88 (lower number = better wear properties)
ASTM D 695	Compressive Strength	81,700 psi
NCHRP Procedure T4-33	Impact Resistance	No substantial damage

WARRANTY (Cast Iron)

TufTile, Inc. 5-Year Limited Warranty. TufTile, Inc. values your business, and the TufTile, Inc. tactile tile (the “product”) you purchased comes with a limited warranty that the product will be free from defects for a period of five years from date of installation subject to ordinary wear and tear. Failure to comply with recommended applications and installation of the product voids this warranty. Customer misuse including negligence, physical abuse and defects resulting from improper installation are not covered by this warranty. Local building codes may require minimum tactile tile performance specifications and TufTile, Inc. does not warrant product installations that violate building codes. While within the limited warranty period, if the product is not in good working order for its intended purposes, a replacement product shall be made available to the purchaser of the product. Purchaser’s remedy is limited to replacement of the product and no consequential or incidental damages and costs (including, but not limited to, lost profits, labor or transportation costs in connection with the removal, replacement and installation of the product) are recoverable or within the coverage of this limited warranty. Any representations made in connection with the sale of this product that differs from the terms of this limited warranty are not covered and should be brought to the attention of TufTile, Inc. immediately. No claim for replacement of a defective product will be honored without TufTile, Inc.’s reservation of its right to inspect the product for the claimed defect and its determination that the replacement of the product is covered by this warranty. The term of this limited warranty shall commence on the date of installation. Proof of purchase shall be required to be eligible for this warranty and to establish the commencement date of this limited warranty. No warranty replacement of the product is provided unless the purchaser’s written replacement claim is submitted to TufTile, Inc. before the expiration of five years from the date of installation of the product.

TO THE MAXIMUM EXTENT APPLICABLE AND ALLOWABLE UNDER LAW, THERE ARE NO WARRANTIES WHICH EXTEND BEYOND THE FACE OF THE TUFTILE INC. LIMITED WARRANTY, AND TUFTILE INC. DISCLAIMS ALL OTHER WARRANTIES, EXPRESS OR IMPLIED, REGARDING THE PRODUCT, INCLUDING ANY IMPLIED WARRANTIES OF MERCHANTABILITY, FITNESS FOR A PARTICULAR PURPOSE OR NON-INFRINGEMENT. TO THE MAXIMUM EXTENT ALLOWABLE BY FEDERAL AND STATE LAW, THIS WARRANTY SUPPLEMENTS OR SUPERSEDES FEDERAL AND STATE CONSUMER GOODS WARRANTY PROTECTION.

The Law and Detectable Warning Surfaces

FEDERAL

The Americans with Disabilities Act (ADA) (42 U.S.C. 12101 et seq.) is a federal civil rights law that prohibits discrimination against individuals with disabilities. The regulations issued by the Department of Justice include accessibility standards for the design, construction, and alteration of facilities. One of those requirements requires installation of detectable warning surfaces as described in these sections of the ADA Accessibility Guidelines (ADAAG) for Public Rights-Of-Way (July 26, 2011). To view the entire proposed guidelines document go to www.access-board.gov

R305.1.1 Dome Size.

The truncated domes shall have a base diameter of 23 mm (0.9 in) minimum and 36 mm (1.4 in) maximum, a top diameter of 50 percent of the base diameter minimum and 65 percent of the base diameter maximum, and a height of 5 mm (0.2 in).

R305.1.2 Dome Spacing.

The truncated domes shall have a center-to-center spacing of 41 mm (1.6 in) minimum and 61 mm (2.4 in) maximum, and a base-to-base spacing of 17 mm (0.65 in) minimum, measured between the most adjacent domes.

R305.1.3 Contrast.

Detectable warning surfaces shall contrast visually with adjacent gutter, street or highway, or pedestrian access route surface, either light-on-dark or dark-on-light.

R305.1.4 Size.

Detectable warning surfaces shall extend 610 mm (2.0 ft) minimum in the direction of pedestrian travel. At curb ramps and blended transitions, detectable warning surfaces shall extend the full width of the ramp run (excluding any flared sides), blended transition, or turning space. At pedestrian at-grade rail crossings not located within a street or highway, detectable warnings shall extend the full width of the crossing. At boarding platforms for buses and rail vehicles, detectable warning surfaces shall extend the full length of the public use areas of the platform. At boarding and alighting areas at sidewalk or street level transit stops for rail vehicles, detectable warning surfaces shall extend the full length of the transit stop.

R305.2 Placement.

The placement of detectable warning surfaces shall comply with R305.2.

R305.2.1 Perpendicular Curb Ramps.

On perpendicular curb ramps, detectable warning surfaces shall be placed as follows:

1. Where the ends of the bottom grade break are in front of the back of curb, detectable warning surfaces shall be placed at the back of curb.
2. Where the ends of the bottom grade break are behind the back of curb and the distance from either end of the bottom grade brake to the back of curb is 1.5 m (5.0 ft) or less, detectable warning surfaces shall be placed on the ramp run within one dome spacing of the bottom grade break.
3. Where the ends of the bottom grade break are behind the back of curb and the distance from either end of the bottom grade brake to the back of curb is more than 1.5 m (5.0 ft), detectable warning surfaces shall be placed on the lower landing at the back of curb.

R305.2.2 Parallel Curb Ramps.

On parallel curb ramps, detectable warning surfaces shall be placed on the turning space at the flush transition between the street and sidewalk.

R305.2.3 Blended Transitions.

On blended transitions, detectable warning surfaces shall be placed at the back of curb. Where raised pedestrian street crossings, depressed corners, or other level pedestrian street crossings are provided, detectable warning surfaces shall be placed at the flush transition between the street and the sidewalk.

R305.2.4 Pedestrian Refuge Islands.

At cut-through pedestrian refuge islands, detectable warning surfaces shall be placed at the edges of the pedestrian island and shall be separated by a 610 mm (2.0 ft) minimum length of surface without detectable warnings.

R305.2.5 Pedestrian At-Grade Rail Crossings.

At pedestrian at-grade rail crossings not located within a street or highway, detectable warning surfaces shall be placed on each side of the rail crossing. The edge of the detectable warning surface nearest the rail crossing shall be 1.8 m (6.0 ft) minimum and 4.6 m (15.0 ft) maximum from the centerline of the nearest rail. Where pedestrian gates are provided, detectable warning surfaces shall be placed on the side of the gates opposite the rail.

R305.2.6 Boarding Platforms.

At boarding platforms for buses and rail vehicles, detectable warning surfaces shall be placed at the boarding edge of the platform.

R305.2.7 Boarding and Alighting Areas.

At boarding and alighting areas at sidewalk or street level transit stops for rail vehicles, detectable warning surfaces shall be placed at the side of the boarding and alighting area facing the rail vehicles.